

NautoPilot® 5000 Series

Operator Manual

NP 5100

NP 5300

NP 5400

NP 5500

NautoPilot® Operator Unit 102-890 NG001/NG002/NG003
Additional Autopilot Control Unit

Dieses Dokument sowie dessen Inhalt sind urheberrechtlich geschützt. Die Weitergabe, Vervielfältigung und Speicherung sowie die Übersetzung wie auch Verwendung dieses Dokuments oder dessen Inhalts, als Ganzes oder in Teilen und egal in welcher Form, ist ohne vorherige ausdrückliche schriftliche Genehmigung nicht gestattet. Zuwiderhandlungen verpflichten zu Schadenersatz.

Änderungen dieses Dokuments und dessen Inhalt bleiben vorbehalten.

This document and its content are copyright protected. Distribution, reproduction and storage as well as translation and exploitation of this document and its content, in whole or in parts and regardless of what form, are prohibited without prior express written permission. Offenders will be held liable for the payment of damages.

Changes and modification to this document and its content reserved.

The present manual has been drawn up as a description and reference book.
It will help answer questions and will solve problems in the quickest possible manner.

Before operating the equipment read and follow the instructions and hints in this manual.

For this purpose, refer to the table of contents and read the corresponding chapters thoroughly.

If you have any further questions, please contact us on the following address:

RAYTHEON ANSCHÜTZ GMBH
Zeyestr. 16 - 24
D-24106 Kiel
Germany

Tel. +49 431 / 3019 - 0
Fax +49 431 / 3019 - 291

All rights reserved. No part of this manual may be copied, neither mechanically, electronically, magnetically, manually nor otherwise, or distributed, forwarded or stored in a data bank without written permission of RAYTHEON ANSCHÜTZ GMBH.

Copyright:
RAYTHEON ANSCHÜTZ GMBH
Zeyestr. 16 - 24
D-24106 Kiel
Germany

Since errors can hardly be avoided in the documentation in spite of all efforts, we should appreciate any remark and suggestion.
Subject to alterations.

Change History

Edition	Date	Change
001	March 2020	Toe Angle added in chapter 2.3.6.4 and aligned with service manual, note moved to chapter 2.3.6.3, changes added for NG003, 6.3 note (central dimming) changed
002	July 2020	minor changes in list of abbreviations and spelling
003	March 2021	Table 3 updated Several additions to chapter 7 (Responsibility Transfer) Alert List updated and moved to the annex

Table of Contents

1	Description	1
1.1	About the manuals	6
1.2	Technical Data	7
1.2.1	Mechanical Data	7
1.2.2	Electrical Data	7
1.3	Explanation of parameters and operation modes	9
1.3.1	Yawing	9
1.3.2	Rudder	9
1.3.3	Counter rudder	10
1.3.4	Ship Load (for Adaptive mode only)	10
1.3.5	Heading Monitor	10
1.3.6	OFF Heading	11
1.3.7	Course Trim	12
1.3.8	Track Econ	13
1.3.9	Acceleration Monitor (for NautoPilot® 5400 and 5500 only)	13
1.3.10	Adaptive mode (Weather Adaptivity)	13
1.3.11	Information about the Steering Switch	13
1.4	Basic operation modes	14
1.4.1	Explanation of used symbols	15
1.4.2	Standby and not ready (- - -)	15
1.4.3	Operation mode Heading Control	16
1.4.4	Operation mode Course Control (- not for NP 5100 -)	19
1.4.5	Operation mode Track Control	22
1.4.5.1	Starting Track Control by RAYTHEON Anschütz ECDIS	26
1.4.5.1.1	Changing over to Track Control, GO- TO- WAYPOINT Maneuver	30
1.4.5.1.2	Changing over to Track Control RETURN- TO- TRACK Maneuver	31
1.4.5.1.3	Track Change Maneuver	33
1.4.5.1.4	Interruption of Track Control	36
1.4.5.1.5	Changing TO- WPT and NEXT- WPT without Interrupting Track Control	36
1.4.5.1.6	End of Track	38
1.4.5.1.7	Error Considerations	39
1.4.5.1.7.1	No Position	40
1.4.5.1.7.2	No or invalid Status from ECDIS	40

1.4.5.1.7.3	Missing Waypoint (NP5500 only).....	42
1.4.5.1.7.4	Track Control Impossible (NP5500 only)	42
1.4.6	Operation mode Waypoint Steering	45
1.4.7	Manual.....	45
1.4.8	Override.....	46
2	Operation	47
2.1	Operation elements at the NautoPilot® Operator Unit.....	47
2.2	Structure of parameter and adjustments	50
2.3	Touchscreen functions / adjustments	51
2.3.1	Tendency Bar.....	54
2.3.2	Switching between night and day displays	55
2.3.3	Switching and Adjusting Rad/RoT.....	56
2.3.4	Using and switching between Economy and Precision mode (not for NP 5100).....	57
2.3.5	Displays for additional information and records.....	58
2.3.5.1	HDG/Rudder Plot display.....	59
2.3.5.2	Track Data display	62
2.3.5.3	NP 5000 Actual Rudder display	65
2.3.5.4	Acceleration Monitor display (- only for NP 5400 and NP 5500 -)	67
2.3.5.4.1	Application hints for the Acceleration Monitor	70
2.3.5.5	Position Monitoring display (- not for NP 5100 -)	72
2.3.5.6	Ship Data display.....	79
2.3.6	Page function.....	80
2.3.6.1	Heading	82
2.3.6.2	Speed.....	86
2.3.6.3	RoT & Radius	87
2.3.6.4	Toe Angle	88
2.3.6.5	Limit values.....	89
2.3.6.6	Parameter settings.....	90
2.3.7	Test of NautoPilot® Operator Unit.....	92
2.3.8	Quick Tune	93
2.3.8.1	Calling up parameter sets	94
2.3.8.2	Modification of a parameter set.....	96
2.4	Switching ON/OFF	97
3	Summary of possible adjustments, parameter settings and configurations.....	99

4	Modes of operation, recommended adjustments/settings, examples.....	101
4.1	Explanation of symbols used at the Autopilot.....	101
4.2	General notes and recommendations	102
4.3	Heading Control.....	103
4.3.1	Precondition for switching from Standby mode to Heading Control mode	103
4.3.2	Procedure to switch from Standby or Override to Heading Control mode.....	105
4.3.3	Procedure to switch from Course Control mode to Heading Control mode	106
4.3.4	Procedure to switch from Track Control mode to Heading Control mode	107
4.3.5	Switching off the Heading Control mode	108
4.3.6	Heading change in Heading Control mode.....	109
4.3.6.1	Preselected heading change in Heading Control mode	110
4.3.6.2	Direct heading change in Heading Control mode.....	112
4.4	Course Control.....	113
4.4.1	Preconditions for switching to Course Control mode.....	113
4.4.2	Procedure to switch from Heading Control mode to Course Control mode.....	115
4.4.3	Procedure to switch from Track Control mode to Course Control mode	116
4.4.4	Switching off Course Control mode.....	116
4.4.5	AS application.....	117
4.4.6	Course change in Course Control mode	118
4.4.7	Lost position value in Course Control mode.....	121
4.5	Track Control	121
4.5.1	Track Control mode with RAYTHEON Anschütz ECDIS.....	121
4.5.2	Preconditions for switching to Track Control mode.....	122
4.5.3	Waypoint steering mode in combination with GPS, chart plotter or equivalent navigation system.....	123
4.5.4	Switching off Track Control and Waypoint Steering mode.....	127
5	Description Additional Autopilot Control Unit (AACU)	130
5.1	Switching ON / OFF	130
5.2	Operation elements of the Additional Autopilot Control Unit.....	131
5.2.1	Date and Time Information.....	131
5.2.2	Navigation.....	132
5.2.3	Autopilot Values.....	133
5.2.4	Menu	133
5.2.5	Panel	134
5.2.6	Control.....	136

5.3	Using the Joystick	136
5.4	Operation	138
5.4.1	Heading Control	138
5.4.2	Course Control	138
5.5	Set Rudder Limit	140
5.6	Alerts of the Additional Autopilot Control Unit	141
5.7	Show / Hide the Curved Heading Line	141
5.8	Switching between night and day display (dimming) Change Display Colors	142
5.9	Adjust Dimming	143
6	Superior operation features	144
6.1	Changing the license key	144
6.2	Software update	144
6.3	Handling of more than one NautoPilot® Operator Unit in a steering system (Master - Slave - application)	145
6.3.1	OU Display indication	147
6.3.2	Procedure to change NautoPilot® Operator Unit status (active - inactive)	148
6.4	Handling of more than one NautoPilot® Operator Unit in a steering system (Master - Master - application)	150
6.4.1	Specifics for a Master - Master - Application	150
7	Alert/status message handling	152
7.1	Alert Management Icons	155
7.2	Possible alarms, warnings and cautions	156
7.3	Other alarms	157
7.3.1	Central alarm	157
7.3.2	System alarm	157
7.3.2.1	Specials on Heading Failure	158
8	Annex	159

Table of Figures

Figure 1: NautoPilot® 5000 Series, Operator Unit.....	2
Figure 2: Additional Autopilot Control Unit (AACU).....	4
Figure 3: Standalone application for the NautoPilot® 5000 Series	5
Figure 4: Integrated application of NautoPilot® 5000 Series	5
Figure 5: Course Trim angle	12
Figure 6: Heading Control after manual set heading adjustment	18
Figure 7: Principle of Course Control versus Heading Control.....	19
Figure 8: Explanations for a heading change in Course Control.....	20
Figure 9: Principle of Course Control display	20
Figure 10: Course Control after manual set heading adjustment.....	21
Figure 11: Principle of Track Control.....	23
Figure 12: Example for GO- TO- WAYPOINT Maneuver for NP5100, NP5300 and NP5400	27
Figure 13: Geometrical Requirements of GO- TO- WAYPOINT maneuvers.....	28
Figure 14: Example of Five Different GO- TO- WAYPOINT maneuvers depending on the initial heading	28
Figure 15: Changing over to Track Control - on transmitting a FROM- WPT by the ECDIS.....	32
Figure 16: Procedure of the Track Change maneuver (Example).....	33
Figure 17: Extreme Case Example of a Track Change maneuver	35
Figure 18: Changing TO- WPT and NEXT- WPT without Interrupting Track Control	36
Figure 19: Intended RETURN- TO- TRACK maneuver Impossible with the Ship too Close to the TO- WPT.....	43
Figure 20: Track Control impossible with the Distance to the Track too large.....	43
Figure 21: NautoPilot® Operator Unit (operation elements)	47
Figure 22: Structure to adjust parameters and values	50
Figure 23: First display (after switching ON the NautoPilot® Operator Unit).....	51
Figure 24: Tendency bar	54
Figure 25: First display (after switching ON the NautoPilot® Operator Unit in night mode, black/white) .	55
Figure 26: First Display (heading changes with RoT is selected).	56
Figure 27: First Display (Eco/Prec switchover).....	57
Figure 28: Switching to display selection.....	58
Figure 29: Displays for HDG /Rudder Plot.....	59
Figure 30: Example of a SET request after a parameter has been changed	59
Figure 31: Displays for Track Data	62
Figure 32: Example of a request to press SET after a parameter has been changed.....	63
Figure 33: Display for NP 5000 Actual Rudder with one and 2 rudders	65

Figure 34: Displays for Acceleration Monitor	67
Figure 35: Example of a request to press "SET" after a parameter has been changed.....	69
Figure 36: Display for the Position Monitoring function (no limit exceeded)	72
Figure 37: Display for the Position Monitoring function (limit exceeded)	73
Figure 38: Display for the Position Monitoring function (limit exceeded and different drift)	74
Figure 39: Display for the Position Monitoring function (general information)	75
Figure 40: Displays for Position Monitoring (adjustments)	76
Figure 41: Example of a request to press SET after a parameter has been changed	78
Figure 42: Display of Ships data (example)	79
Figure 43: Page function displays	80
Figure 44: Indicated values/parameters (Page function)	81
Figure 45: Calling- up values for adjustment (Page function)	82
Figure 46: Heading source selection (Page function)	82
Figure 47: Heading source selection ("Page" function) - heading source not available or INS.....	84
Figure 48: Heading sensor failed	84
Figure 49: Speed sensor and Heading sensor doubtful.....	85
Figure 50: Speed sensor and Heading sensor failed.....	85
Figure 51: Speed source and speed value (Page function)	86
Figure 52: RoT & Radius (Page function).....	87
Figure 53: Toe Angle.....	88
Figure 54: Limit values (Page function)	89
Figure 55: Parameter setting (Page function).....	90
Figure 56: Example of a request to press SET after a parameter has been changed	91
Figure 57: Selection of adaptive and non-adaptive mode.....	93
Figure 58: Displays for parameter sets.....	94
Figure 59: Modification of a parameter set	96
Figure 60: Autopilot Values	133
Figure 61: Section Panel.....	134
Figure 62: Section Control	136
Figure 63: Joystick	136
Figure 64: Master- and Slave NautoPilot® Operator Units.	145
Figure 65: Principle of master slave NautoPilot® Operator Unit	146
Figure 66: Indication OU Display" in slave operator unit.....	147
Figure 67: Alert messages at the NautoPilot® Operator Unit (example for long text)	152
Figure 68: Alert messages at the NautoPilot® Operator Unit (example for short text)	152

Table of Tables

Table 1	Overview NautoPilot® types (variants)	4
Table 2	Used symbols.....	15
Table 3	NautoPilot® Operator Unit (operation elements)	47
Table 4	Operating and monitoring elements of initial display after turning-on.....	52
Table 5	Softkeys for Display Selection	58
Table 6	Softkeys for HDG/Rudder Plot Display	60
Table 7	Softkeys for Track Data Display	63
Table 8	Softkeys for NP 5000 Actual Rudder Display.....	66
Table 9	Softkeys for Acceleration Monitor Display.....	68
Table 10	Definitions within the Position Monitoring Display.....	75
Table 11	Softkeys for Position Monitoring Displays.....	77
Table 12	Indicated values/parameters (Page function).....	81
Table 13	Meanings of Limit Values (Page function)	89
Table 14	Meanings of parameter Settings (Page function).....	91
Table 15	Meanings of Parameter Memory	95
Table 16	Meanings of parameters for Parameter sets.....	97
Table 17	Summary of possible Adjustments, Parameter Settings and Configurations.....	99
Table 18	Checks to be made before switching from Standby to Heading Control.....	104
Table 19	Procedure to switch from Standby to Heading Control Mode.....	105
Table 20	Procedure to switch from Course Control mode to Heading Control Mode	106
Table 21	Procedure to switch from Track Control mode to Heading Control Mode.....	107
Table 22	Procedure to switch off Heading Control Mode.....	108
Table 23	Procedure for changing heading in Heading Control mode.....	109
Table 24	Procedure for changing preselected heading in Heading Control mode	110
Table 25	Procedure for a direct heading change in Heading Control mode.....	112
Table 26	Checks to be made before switching to Course Control mode.....	113
Table 27	Procedure to switch from Heading Control mode to Course Control mode	115
Table 28	Procedure to switch off Course Control mode in standalone application.....	116
Table 29	Procedure to switch off Course Control mode in AS application	117
Table 30	Procedure for a course change in Course Control mode	119
Table 31	Checks to be made before switching to Track Control with RAYTHEON Anschütz ECDIS	122
Table 32	Checks to be made before switching to waypoint steering using GPS, chart plotter or equivalent navigation systems	126

Table 33	Procedure to switch off Track Control mode	127
Table 34	Operation elements AACU	131
Table 35	Example Section Navigation (AACU).....	132
Table 36	Description of the Quality Indicators according to IEC 62288	132
Table 37	Description of the Quality Indicators according to IEC 62288	133
Table 38	Menu Bar Content	133
Table 39	Section Panel	134
Table 40	Section Control.....	136
Table 41	Joystick operation.....	137
Table 42	Procedure to change NautoPilot® Operator Unit status (active - inactive) without change of control mode	148
Table 43	Procedure to change NautoPilot® Operator Unit status (active - inactive) with change of control mode	149
Table 44	Alarms/messages alerts	153
Table 45	Alert management icons.....	155

List of Abbreviations and Acronyms

Accel.	Acceleration
AS	Advanced Steering
APB	Autopilot Sentence B
AACU	Additional Autopilot Control Unit
BAM	Bridge Alert Management System
CAN	Controller Area Network
Count.	Counter (- rudder)
deg	Degree
DGPS	Differential Global Positioning System
DR	Dead Reckoning
ECDIS	Electronic Chart Display and Information System
Eco/Prec	Economic/Precision
CCRS	Consistent Common Reference System
COG	Course Over Ground
Ctrl	Control
IBS	Integrated Bridge System
ID	Identification
IEC	International Electrotechnics Commission
II	Integrated Instruments (NMEA- talker for ECDIS)
IMO	International Maritime Organization
INS	Integrated Navigation System
IP	Internet Protocol
GPS	Global Positioning System
GUI	Graphical User Interface
HDG	Heading
HP	Hilfspapier (auxiliary paper)
kn	Knots
LC	Loran C
LED	Light Emitting Diode
Mag	Magnetic compass
man	Manual
min	Minute(s)
Nb	Number
NM	Nautical Mile
NMEA	National Marine Electronics Association

NP	NautoPilot®
OM	Operator Manual
Para/Mem	Parameter/Memory
pt	port
RAD	Radius
RoT	Rate of Turn
RS	Recommended Standard
Rud	Rudder
SM	Service Manual
SOG	Speed Over Ground
SOLAS	Safety of Live at Sea
SPD	Speed
stb	Starboard
STW	Speed Trough Water
TMC	Transmitting Magnetic Compass
WPT	Waypoint
WOL	Wheel over line
XTD	Cross Track Error



Safety Instructions

To prevent dangerous situations, check the traffic at sea and the sea area before and while using any control function with the Autopilot.

Activated control functions, such as Heading Control, Course Control or Track Control shall be monitored after their activation.

Waypoint steering mode must not be used on vessels falling under SOLAS convention.

Correct performance after alterations of heading / course shall be monitored.

All control and monitor functions / modes shall be checked on a regular basis.

NautoPilot® 5000 allows to define a rate of turn radius value for heading / course alterations. Make sure that these values are appropriate to the vessel's maneuvering characteristics or present operating conditions.

For radius-controlled heading / course alterations a valid speed input is mandatory. Use rate of turn controlled heading / course alterations in case of invalid speed data.

NautoPilot® 5000 allows to define a rudder limit value for heading / course alterations. Make sure that these values are appropriate to the vessel's maneuvering characteristics or present operating conditions.

Wrong settings for radius, rate of turn, rudder and counter rudder could cause high heeling angles.

Use of magnetic compass as a heading for Track Control mode is not permitted.

Use a soft pen (or fingertip) to operate the touch display. Do not use sharp or scratching items.

The buttons at the front side must never be operated by a pointed object (ball point pen, pencil, etc.)

For cleaning the buttons and the display, a commercial, acid free agent is to be used.

Adjustment, configuration and operation are strongly influenced by the steering system and its application / performance. Therefore, it is absolutely obligatory that configuration, adjustment and operation must be performed by well trained, experienced personnel only.



NautoSteer AS consists of 2 independent steering control systems that are technically separated from each other. These steering control systems can be selected by using the steering mode selector switch.

In NFU direct mode the valves / steering gear are operated directly without the use of electronics.

In main mode a closed loop control system is used.

Recommendation:

In case of any failure in either 1 of the 2 independent steering control systems please switch to the other mode by using the steering mode selector switch to retrieve the steering capabilities of the control system (see also section 1.3.11).

Please note that depending on the system design the steering control system may not contain a steering mode selector switch. In this case it is strongly recommended to be familiar with the steering control system in order to select the right steering control in emergency situations.



There are 2, versions of the NautoPilot® Operator Unit available. They differ in the housing dimensions.

For version

- NG001 see appended dimensional drawing 102-890. HP005
- NG002, NG003 see appended dimensional drawing 102-890. HP015

1 Description

The NautoPilot® 5000 Series is part of the Steering System Family AS (Advanced Steering) and is used to control navigation at sea for all sizes of seagoing vessels. The NautoPilot® 5000 Series was designed for use in high speed craft, but is equally suited for all types of mono- and multihull vessels with any kind of rudder control.

The NautoPilot® 5000 Series complies with IMO resolutions.

By setting a number of easily accessible parameters, the Autopilot's steering characteristics can be adjusted (depending on the type of NautoPilot® 5000 Series) to the vessel's dynamic behavior and the prevailing conditions (sea state, load).

There are 4 different types of NautoPilot® (which vary in different operation modes) and 2 different applications:

Type: NP 5100

Type: NP 5300

Type: NP 5400

Type: NP 5500

Application: Stand alone

Application: Integrated



Figure 1: NautoPilot® 5000 Series, Operator Unit

NautoPilot® 5100

Manual adaption to weather and sea state with 6 sets of parameters (such as rudder, counter rudder, yawing).

- Heading Control
- Track Control (in combination with Raytheon ECDIS)

NautoPilot® 5300

Automatic adaption to weather and sea state using a rudder variance control. Increased performance by adjusting ECONOMY/PRECISION mode (ECONOMY = low rudder activity; PRECISION = higher steering accuracy).

- Heading Control
- Track Control (in combination with Raytheon ECDIS)
- Course Control (Course Over Ground)

NautoPilot® 5400

Automatic adaption to weather and sea state using a rudder variance control. Increased rudder performance by adjusting ECONOMY/PRECISION mode (ECONOMY = low rudder activity; PRECISION = higher steering accuracy). Track change in Track Control with radius cross track distance parameters (XTD). Fast drift compensation by implementation of Kalman filter technology.

- Option to select Acceleration Monitor.
- Heading Control
- Course Control
- Track Control in combination with an ECDIS
 - approved for IEC 62065 Cat C. in combination with Raytheon ECDIS
 - not approved for third party ECDIS equipment

NautoPilot® 5500

Automatic adaption to weather and sea state using a rudder variance control. Increased performance by adjusting ECONOMY/PRECISION mode (ECONOMY = low rudder activity; PRECISION = higher steering accuracy).

Track change in Track Control with radius cross track distance parameters (XTD). Fast drift compensation by implementation of Kalman filter technology.

- High Precision
- Option to select Acceleration Monitor
- Heading Control
- Course Control (high precision Track Control with rudder variance control and Kalman filter technology)
- Track Control in combination with an ECDIS
 - approved for IEC 62065 Cat C. in combination with Raytheon ECDIS
 - not approved for third party ECDIS equipment



Please note:
The different types can be activated via "software keys" and are available on special order.

Additional Autopilot Control Unit (AACU)

Figure 2: Additional Autopilot Control Unit (AACU)



The Additional Autopilot Control unit can be purchased in addition (optional) to the NautoPilot®.

It is a slave console of the NautoPilot® and consists of a joystick and a 12 monitor.

In addition, the AAC enables the graphical representation of a curved heading line in the Raytheon SYNOPSIS NX ECDIS and RADAR.

Table 1 Overview NautoPilot® types (variants)

	Heading Control	Course Control	Weather Adaptivity	Track Control Category B*	Track Control Category C*	Cross Acceleration Monitor	High Precision Controller
NP 5100	✓			✓			
NP 5300	✓	✓	✓	✓			
NP 5400	✓	✓	✓		✓	✓	
NP 5500	✓	✓	✓		✓	✓	✓



Please note:
 This manual contains information for all types and modes.
 Some sections are marked for their validity.

Note:

* For Track Control Category B and C:

In February 2014 the test standard for track control systems IEC 62065 has been re-vised to edition 2. Please not that only NautoPilot® 5400 and 5500 have been adapted to the latest test standard (introduced with software version E03).

NautoPilot® 5100 and 5300 are compliant to IEC 62065 edition 1 with software versions E01 and E02.

Standalone application (always with a connected Autopilot Interface, type 102-891) This application may only perform rudder control with an additional Raytheon Anschütz Autopilot Interface, type 102-891.

Figure 3: Standalone application for the NautoPilot® 5000 Series

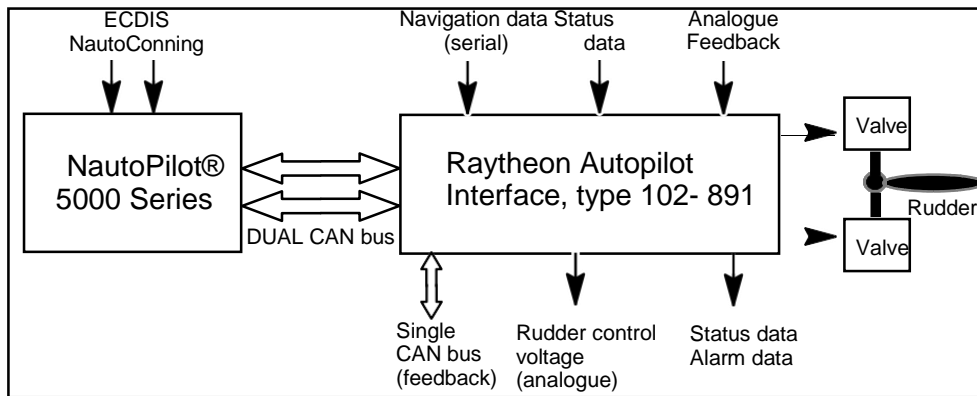

Integrated application (also designated as NautoSteer Advanced Steering Control or AS)

For an integrated application the NautoPilot® has to be integrated in a bus-oriented technology with sensors, track control systems and rudder control elements (Follow UP Amplifier).

Figure 4: Integrated application of NautoPilot® 5000 Series

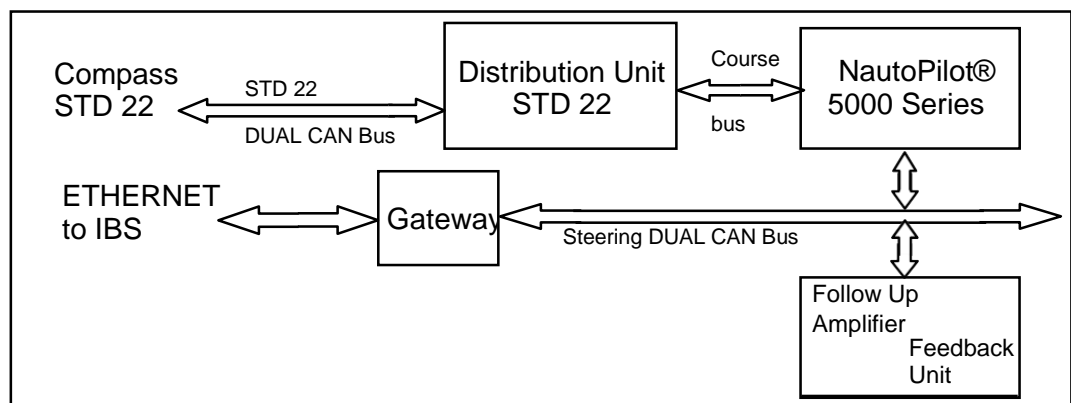

A maximum of 9 Master NautoPilot® Operator Units can be installed in a steering control system. Each Master NautoPilot® Operator Unit can be combined with up to 10 Slave Operator Units.



An installation of 2 master NautoPilot® Operator Units is possible only in an integrated application not in combination with an Autopilot Interface.

1.1 About the manuals

There are 2 different manuals for the NautoPilot® 5000 Series:

- Operator Manual
- Service Manual

The Operator Manual contains a basic description, technical data and operating procedures.

The Service Manual covers installation, commissioning, maintenance and repair.

In some cases, the manual for an Autopilot Interface, type 102-891 should also be referred to.



If it is not specified, all data refers to all versions of NautoPilot®, type 102- 890.

Detailed data are specified with the following versions:

NautoPilot® 5100
NautoPilot® 5300
NautoPilot® 5400 and
NautoPilot® 5500

1.2 Technical Data

1.2.1 Mechanical Data

For dimensions, type of enclosure and weight see the appended Dimensional Drawing 102- 890.HP005 for Autopilot 102- 890.NG001, Dimensional Drawing 102- 890.HP015 for Autopilot 102- 890.NG002, NG003.

1.2.2 Electrical Data

Supply voltage (plug B12)	24 V DC (18 to 36
V DC) Power consumption	Approx. 25 W
Ambient temperature (operation)	- 25 °C to +55 °C
Ambient temperature (storage)	- 40 °C to +70 °C

Outputs (Status):

- Status and alarm contacts (plugs B3, B4, B5 and B6)	Output load 30 V DC, I _{max.} 1 A
--	--

Inputs (Status):

Status (plugs B10 and B11)	24V DC, I _{max.} 5 mA
----------------------------	--------------------------------

Outputs/Inputs:

Serial in/out (plugs B8 and B9)	RS422 (NMEA)
CAN bus (plugs B21 and B22)	according to RAN CAN bus
specification LAN	(ETHERNET)

Signal Inputs:

Gyro Compass, Satellite Compass	Course Bus or
NMEA* Magnetic Compass/Fluxgate	Course Bus or
NMEA* Speed Log	Course Bus or
NMEA*	
Position Receiver	NMEA*
ECDIS (for Track Control)	according to IEC 62065, APB NMEA*

*NMEA according to IEC 61162- 1, - 2

Electrical Data Additional Autopilot Control Unit (AACU)

12" Monitor:

Supply voltage	18- 34 V DC Galvanic isolated Optional Dual input DC power, Galvanic isolate
Power consumption	Approx. 25 W
Ambient temperature (operation)	- 15 °C to +55 °C
Ambient temperature (storage)	- 25 °C to +70 °C
Relative Humidity	8 to 95 % (non-condensing)

Joystick:

Supply voltage	5 V DC +/- 0,01 V DC
(USB) Ambient temperature (operation)	- 25 °C to +70 °C
Ambient temperature (storage)	- 40 °C to +70 °C

1.3 Explanation of parameters and operation modes

1.3.1 Yawing

Must be set according to sea state.

The yawing setting determines rudder activity and heading accuracy for the Autopilot's control properties.

The possible range of parameter yawing is 1 to 6 (in increments of 1). Default value is 2.

The optimum setting is obtained by means of observation.

Yawing = 1 signifies control with the greatest amount of activity
(maximum accuracy level) ⇒ calm sea.

Yawing = 6 signifies control with the lowest amount of activity (minimum
accuracy level) ⇒ high sea state.

If the setting is not optimized, the steering gear can become over- stressed.
Large rudder angles can lead to speed loss in a seaway.

Decrease of yawing gives a better control performance but with the drawback of
more rudder activity.

Increase of yawing gives a less rudder activity but with the drawback of less control
performance.

1.3.2 Rudder

Heading deviation needs to be corrected by means of a rudder movement
effectivity typical to the ship.

The rudder setting determines the ratio of rudder angle to heading deviation.

The possible range of parameter rudder is 1 to 9 (in increments
of 1). Default value is 5.

Rudder too large (parameter = 9):

Unstable behavior ⇒ over- reacts to a heading change.

- overshoots when heading is changed.

Rudder too small (parameter = 1): Heading Control too inaccurate

- pre- configured rate of turn not reached during heading change maneuver

Decrease rudder if the intensity of the rudder movement is too strong.

Increase the rudder intensity if the rudder movement is too weak during heading keeping.

1.3.3 Counter rudder

Based on its bulk and load, each ship has a time constant typical to the ship, which needs to be controlled during heading change maneuvers.

Before the new set heading is reached, the turning speed of the ship must be reduced by a counter rudder action (movement).

This effect is achieved by the counter rudder setting.

The possible range for parameter counter rudder is 0 to 9 (in increments of 1) Default value is 5.

Counter rudder too high (parameter = 9):

The ship reaches the new set heading too slowly.

Counter rudder too small (parameter = 0):

The ship overshoots the selected heading.

Decrease counter rudder if the rudder movement in counter direction at the end of heading change is too strong or comes too early resulting in too slow setting to the new set heading value.

Increase counter rudder if the rudder movement in counter direction at the end of a heading change is too weak or comes too late resulting in too much overshoot settling to the new set heading value.

1.3.4 Ship Load (for Adaptive mode only)

Each ship has a typical behavior depending on the load of a ship.

This parameter considers the ship's load for the steering control by an Autopilot. This parameter is input according to the load percentage. 10% is for the lowest load condition. 100% is for a maximum ships load.

1.3.5 Heading Monitor

The Heading Monitor function monitors the heading from a Gyro compass and a

magnetic compass.

The monitoring threshold is set via the Page function (Page →Limit →Heading Monitor) at the initial display. It allows settings from 5° to 30° in increments of 1°.

The difference between Gyro heading and magnetic heading exceeds the preset threshold, an alert is generated.

During a heading change maneuver this function is automatically paused, due to the inert behavior of the Magnetic compass.

For switching on or off the Heading Monitor refer to Installation Manual, chapter on Heading Monitor.

1.3.6 OFF Heading

This function compares the actual heading value against the set heading value. There is an alarm if the limit between set heading and actual heading exceeds a pre-adjusted value (Page →Limit →OFF Heading). See also section 2.3.6.4. The possible range for pre-adjusted OFF Heading value 5° to 30° (in increments of 1°). The alarm is suppressed for a calculated time after a heading change maneuver (calculation is based on RAD or RoT → time window).

The time window is calculated from the difference in the desired heading and the preselected turning rate.

If, during the heading change maneuver, the ship reaches the heading alarm threshold within the time window, no alarm is triggered.

Note:

The desired value for the rate of turn (RoT) depends on the physical characteristics of the ship. The ship should be able to perform the turning value. Desired rates of turn exceeding the turn capability of the ship result in the OFF heading alarm being triggered before the ships heading reaches the desired Set Heading.

This effect also occurs if the rudder limit is adjusted too close, so the selected RAD/ RoT- limit is not achievable.

On taking the Autopilot into operation, make sure that the basic settings (configurations) are precisely adjusted. In order to control the turning rate, a sufficient rudder amplification (optimization of rudder parameters) must be ensured.

If the desired heading, the radius, or the turn rates are changed during a heading change maneuver, the time window will immediately be calculated anew.

1.3.7 Course Trim

Figure 5: Course Trim angle

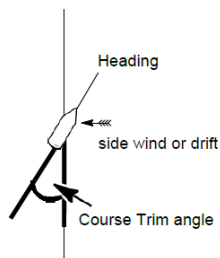

Please note:

The Course Trim angle can be adjusted for the modes Course Control and Track Control (Page → limits → Course Trim). See section 2.3.6.4. The setting angle of the vessel is limited to this adjusted value. (This is valid for NP5100 to NP5400.)

Achieving this angle, the alarm Course Trim is activated.

If the Course Trim angle is adjusted too small it could happen, that the vessel will be off the track. In this case the Course Trim angle must be changed or another control mode must be selected.

The Course trim angle defines the angle between the actual course (calculated with speed and position) and the actual heading value from a heading sensor. Course and heading may have different values, caused by drift, wind or sea state.

For NP5500 only

If the limit for the Course Trim angle is reached the alarm Course Trim is activated as for the other NautoPilots. The maximum Course Trim angle for the NP5500 depends on the actual ship's speed and actual drift. So, it is possible for the course trim angle to be greater than 30° in order to keep Track.

1.3.8 Track Econ

This parameter is for NP5500 only and is used to adjust the Economy Mode (see section 1.3.10) in Track Control. If the value of this parameter is increased, rudder activity will be reduced.

1.3.9 Acceleration Monitor (for NautoPilot® 5400 and 5500 only)

(see also section 2.3.5.4).

As a unique feature, NP 5400 and 5500 integrate an Acceleration Monitor that monitors the ship's cross acceleration and provides a warning if a cross acceleration limit is exceeded. This helps to avoid damage or accident due to high acceleration stresses that might occur for example during a heading change at high speed and finally increases safety for life, ship and cargo.

In the setup window the acceleration limit is directly input (Page → Limit → Acceleration Limit) or calculated with values like Rate of Turn (RoT) and speed. An Alarm is provided if the actual speed and radius/RoT cause accelerations larger than defined value.

In addition, this Acceleration Monitor function can be switched on and off.

1.3.10 Adaptive mode (Weather Adaptivity)

This mode controls the optimal heading or Track Control via the Economy or Precision function. This function ensures that the NautoPilot® 5000 Series (except NautoPilot® 5100) reacts automatically to the current weather conditions.

The Economy mode guarantees a reduction of the rudder movement with less course keeping accuracy. The reduction of the rudder movement results in less forward thrust loss and consequently less fuel consumption.

The Precision mode guarantees exact course keeping. The rudder movement can be notably reduced by using yawing settings.

1.3.11 Information about the Steering Switch

The Steering Switch (also designated as Main Steering Switch, Steering Selector or Steering Mode Selector Switch) does not belong to the NautoPilot® 5000 Series directly, but its function is essential for some operating procedures.

This switch has a minimum of 2 switch positions. These switch positions may also have different designations (for example HAND and AUTO, NFU direct and MAIN, MAIN and SECONDARY or NFU and FU).

The different designations are caused by different steering philosophies, different manufacturers and different user requests.

It is absolute necessary to become familiar with its designation and function within a steering system.

For the steering system described in this manual, the switch has the switch positions HAND and AUTO but with different functions depending on the application.

Function:

Standalone application: Switch position AUTO means Autopilot operation is activated in this switch position (steering control loop).
Switch position HAND means no Autopilot operation.

AS application: Switch position AUTO means it is possible to activate an Autopilot of NautoPilot® 5000 Series (steering control loop). Switch position HAND means a direct influence to the hydraulic valves of a steering system.

1.4 Basic operation modes



During any Autopilot control mode, switching over from one connected sensor (for heading, position or speed) to another sensor should not be performed.

However, if a switch over must be performed, it must be verified that the difference in the sensor data is as small as possible.









Please note:

Some basic operating modes differ in the type of application, either standalone application or AS application.

1.4.1 Explanation of used symbols

Some symbols are used to explain these modes. Below mentioned table shows their meaning.

Table 2 Used symbols

Symbol	Meaning
	Key actuation
	LED flashing
	LED out
	LED alight
	Acoustical signal on
	Acoustical signal off
Go to Waypoint	Top bar of the display. For colors and symbols, see section 7 and , 7.1 for message texts, see table in the annex.

1.4.2 Standby and not ready (- - - -)

In general: Standby and not ready are no operation modes, but they are status of a NautoPilot®. This status is essential for a switching over to Autopilot control modes.

The status Standby and not ready are indicated at the top right corner of the Autopilot display.

Standalone application:

If the status Standby is displayed in Autopilot Display and the Main Steering Switch is switched into a switch position with Autopilot control, the NautoPilot® is active at once in Heading control.

Attention: The NautoPilot® starts to control at once (actual heading is set heading). This is important to note especially during heading change.

AS application:

If the status Standby is displayed it means, that a NautoSteer System is active. If manual mode (Manual is displayed at the top right corner) is active and the Main Steering Switch is switched into position AUTO the status Standby is displayed at the top right corner of the display and the NautoSteer System is ready for control. The NautoPilot® starts to control after the Heading button is pressed (actual heading is set heading).

-- -- -- (Not ready)

If a dotted line is displayed at the top right corner of the display the Autopilot cannot be activated (neither in a Standalone application nor in an AS application). It means, that the Autopilot is not able to perform any control function. The reasons are for example no heading input or no speed input, and are displayed as an alert message (see section table in the annex).

1.4.3 Operation mode Heading Control

The Heading Control operation is activated when the steering system is not in manual mode or when the autopilot is active.

Heading Control can be performed with a heading value from a gyro compass, from a magnetic compass or in connection with a track planning system.

The appropriate heading source can be selected via the NautoPilot® Operator Unit.

Once activated, the Autopilot controls the heading by comparing the set heading value and the actual heading value. Other adjustable parameters (like yawing, rudder economy or precision) are taken into consideration.

The set heading value is adjusted via the rotary knob and activated either by the SET button or by pressing down the rotary knob.

A direct heading change can be performed by pressing down and turning the rotary knob; in this mode the ship follows the new value (see Figure 5).

Please note:

The direction (turn direction) of a heading change depends on the turn direction of the rotary knob.

For step by step instructions for Heading Control/heading change, see section 4.

After switching over from manual steering to steering control via the Autopilot, the actual heading will be taken as the set heading on the Autopilot.

Figure 6: Heading Control after manual set heading adjustment

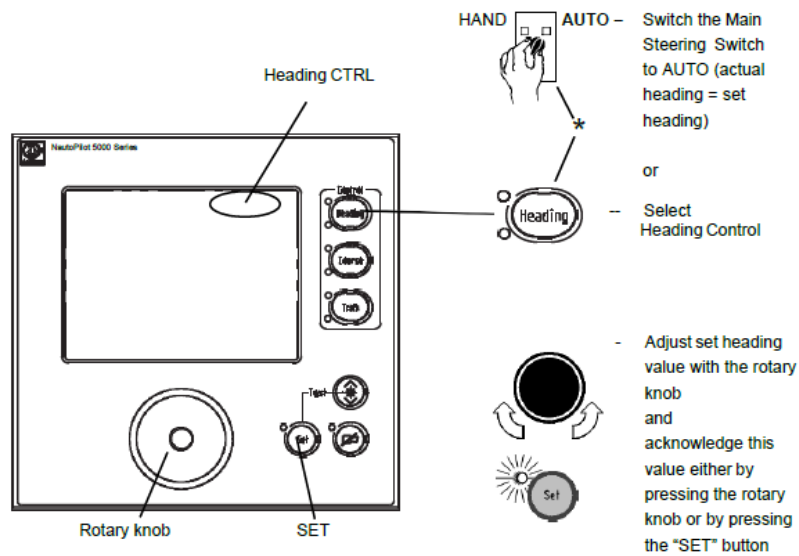

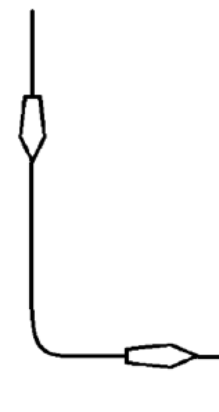
Manual Mode / Standby	180.0	Actual Heading	
	---	Set Heading	
Heading Control	180.0	Actual Heading	
	180.0	Set Heading	
Adjust Set Heading	180.0	Actual Heading	
	090.0	Set Heading	
After Heading Change	090.0	Actual Heading	
	090.0	Set Heading	

* Standalone application: By switching the Main Steering Switch to AUTO the Autopilot controls at once in Heading mode.

AS application: Autopilot must display Manual before. Then, by switching the Main Steering Switch to AUTO, Standby is displayed and the NautoSteer System is ready for control (but the Autopilot is not active). After pressing the button Heading the Autopilot is active in Heading control.

1.4.4 Operation mode Course Control (- not for NP 5100 -)

Figure 6: Principle of Course Control versus Heading Control

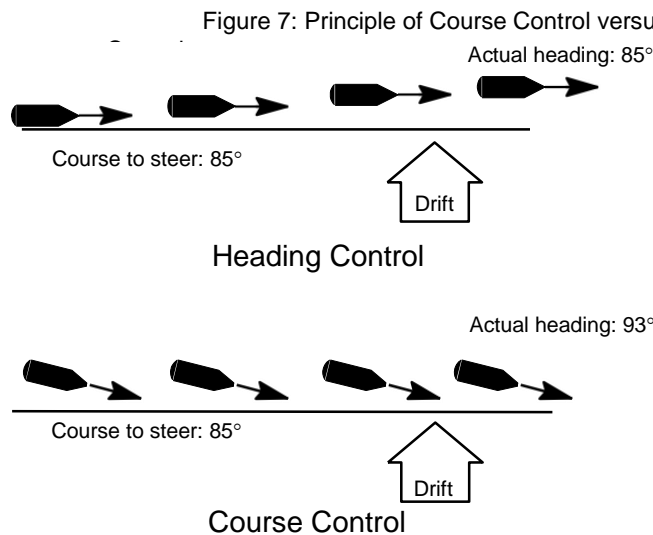

The Course Control operation is activated when the Autopilot is in Heading Control mode and the Course button has been pressed.

When switching from Heading Control mode to Course Control mode the actual heading defines a Course Over Ground line. This course line will be the baseline that must be controlled.

Course control is performed with data from a position sensor and a sensor for Speed Over Ground data. The Autopilot calculates the distance to the course line based on the following data:

- Position
- Speed Over Ground
- Course trim
- Drift, wind
-

Other adjustable parameters (like yawing, rudder, economy or precision) are taken into consideration.

The set Course Over Ground value is adjusted via the rotary knob and activated either by pressing the SET button or by pressing down the rotary knob.

Figure 8: Explanations for a heading change in Course Control

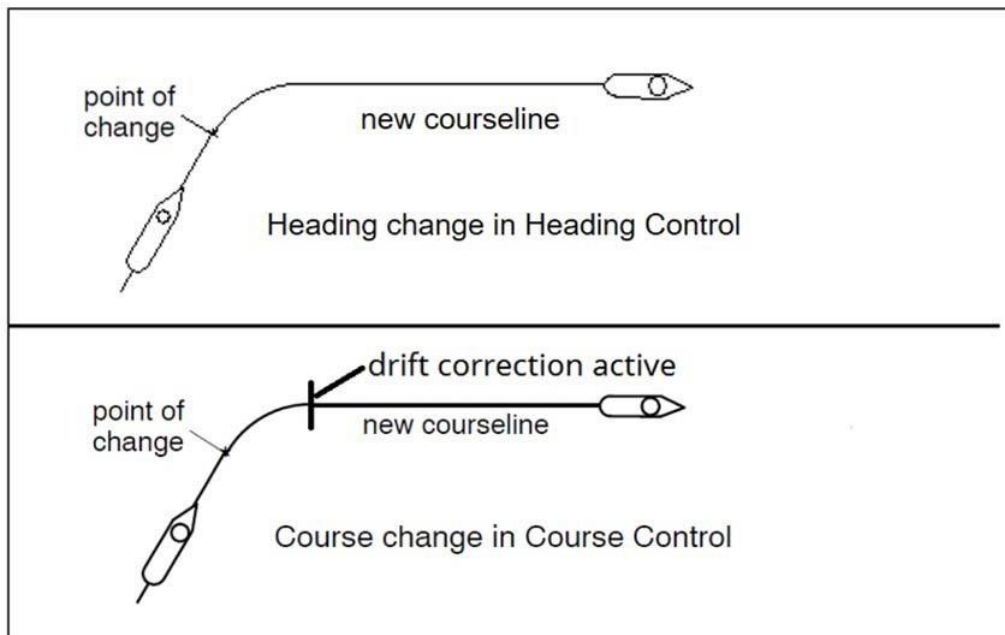

A direct set Course Over Ground change can be performed by pressing and turning the rotary knob. In this mode the ship follows the new value after release of the rotary knob.

Please note:

The direction (turn direction) of a set Course Over Ground change depends on the turn direction of the rotary knob.

After switching over from Heading Control to Course Control via the Autopilot, the actual heading value will be taken as set Course Over Ground. The display shows the actual heading (see Figure 8), the set Course Over Ground value and the distance and direction to the calculated course line.

Figure 9: Principle of Course Control display

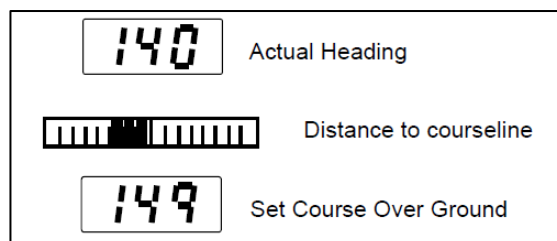

Essential parameters (limits) to observe are:

- Course trim, Track Limit Autopilot and Rudder Limit must be correct adjusted (see section 2.3.6.4).

Please note: The value for track limit Autopilot is used as a monitoring

threshold for the distance to course line in Course Control.

Figure 10: Course Control after manual set heading adjustment

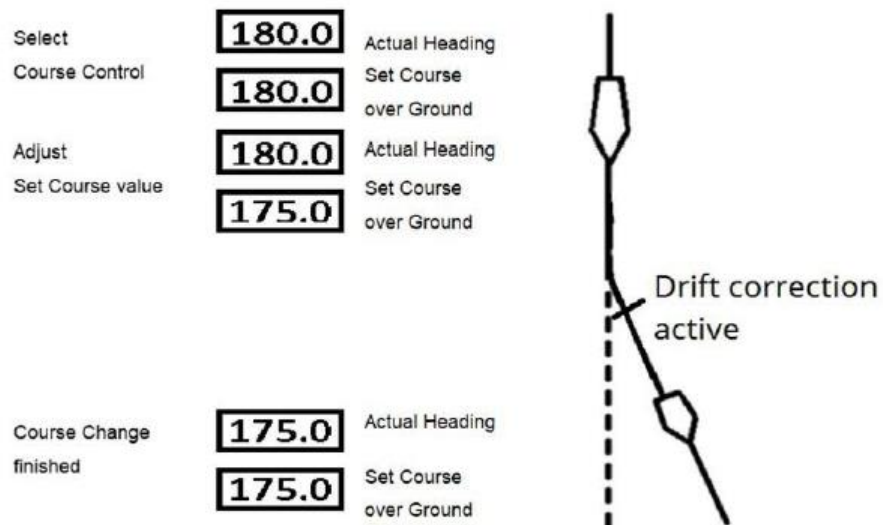
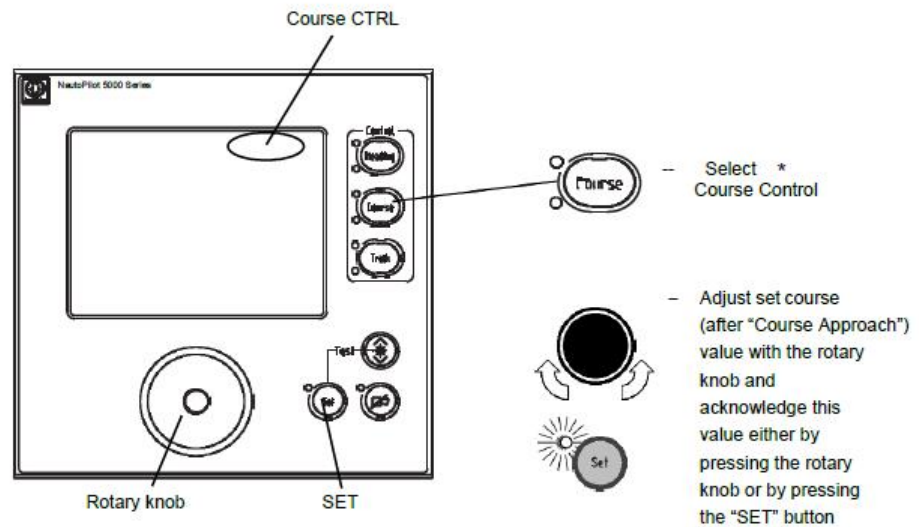

* Independent the type of application (Standalone or AS) a switch over to Course Control is possible only if the control mode is Heading before (see section 1.4.3).

During a course change maneuver, the Drift Correction is disabled and a heading change is performed with the Set Rate of Turn or Radius (depending on setting). During the turn the caution Course Approaching is displayed. When the Heading

Change maneuver is finished (+/- 1° to the Set Course over Ground) the drift correction becomes active again and the caution is deleted.

Rate of Turn influence on Course Control

The Rate of Turn upon activation of Course Control must not exceed 30°/minute.

Speed influence on Course Control

The speed before activation of Course Control mode must not be less than this value, which is configured as the Low speed value.

Otherwise a Speed too slow message is displayed and Course Control mode cannot be activated.

1.4.5 Operation mode Track Control

This mode can be used with different accuracies:

- Category B for NautoPilot® type 5100 and 5300
- Category C for NautoPilot® type 5400 and 5500 (for RAYTHEON Anschutz ECDIS only)

Note:

In February 2014 the test standard for track control systems IEC 62065 has been re-vised to edition 2. Please note that only NautoPilot® 5400 and 5500 have been adapted to the latest test standard (introduced with software version E03).

NautoPilot® 5100 and 5300 are compliant to IEC 62065 edition 1 with software versions E01 and E02.

Track Control is only possible with a connected track planning system.

The NautoPilot® 5000 Series is designed to perform Track Control with a RAYTHEON Anschutz track planning system (ECDIS).

The track planning system defines the input data for the Autopilot; the Autopilot controls the accuracy of the track steering. All data adjusted at the Autopilot for Track Control is used for RAYTHEON Anschutz track planning systems only.



Values for RAD and RoT from the ECDIS are displayed at the Autopilot during Track Control. They may be different from the values which have been adjusted at the Autopilot beforehand and they may exceed the adjustable range of the Autopilot.



The speed value of ECDIS must not be different from the speed value for the control function of the Autopilot. This should be checked before activating "Track Control" mode.

Essential control parameters to adjust at the Autopilot are:

- Rudder limit
- Course Trim

Figure 11 below shows the principle of Track Control with adjusted data from a track planning system.

Figure 11: Principle of Track Control

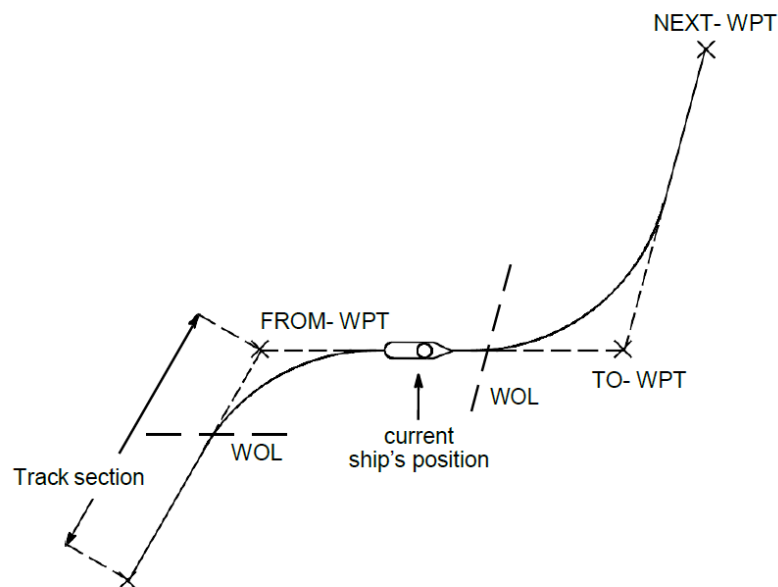

WPT	Waypoint
Track Section	A track section is the route between 2 WPT.
TO- WPT	Waypoint to be steered for. The WPT is considered as a TO- WPT as long as the associated track change maneuver is not terminated and the new track section has not been reached.

FROM- WPT FROM- WPT is the previous waypoint.
NEXT- WPT NEXT- WPT is the waypoint following TO- WPT.
WOL Wheel- over- line. The line of the track where the planned track change maneuver is intended to start.
Approach- Time The approach time is the time before the WOL when the approach message is indicated on the NautoPilot® Operator Unit.
ECDIS **E**lectronic **C**hart **D**isplay and **I**nformation **S**ystem: Track planning system; system for planning the track and for the input of the WPTs.

Control Parameters Rate of Turn (RoT)
NautoPilot® 5100, NP 5300 and NP 5400:

The ECDIS transmits Course Over Ground (COG), Rate of Turn (RoT) and Cross Track Error (XTE) to the Autopilot. The ECDIS transmits no waypoints and the Autopilot re- quests no data for a track.

NautoPilot® 5500 only:

Before Track Control is started, WPTs are transmitted to the Autopilot (up to 4 waypoints). This process is called initialization.

During this initialization all necessary data for Track Control are transmitted to the Autopilot.

Further WPTs (and data) are transmitted during Track Control from the ECDIS to the Autopilot on request of the Autopilot.

After initialization, the Autopilot is switched into Track Control mode and the ship approaches the first track section.

Within a time between 3 to 5 min before a track change maneuver starts, the operator is notified of the forthcoming track change maneuver by means of a message from the Autopilot. The time can be selected at the ECDIS. This message must be acknowledged by the operator. 30 seconds before the track change maneuver starts, the operator is requested by the Autopilot to acknowledge the forthcoming track change. The track change is realized even if those messages are not acknowledged.

At the end of the route, the operator is notified by an alarm that the ship is at track end, and he is requested to change over to Heading Control mode or manual mode.

The activation of Track Control is only possible under the following conditions:

1. The Autopilot is in the operating mode of Heading Control.
2. Track Control is activated from RAYTHEON Anschütz ECDIS.

In general:

Controller parameter like rudder, yawing, economy etc. can be adjusted at the Autopilot. Please note:

Parameters RoT and radius (RAD) limits should be adjusted for a non-RAYTHEON Anschütz ECDIS accordingly.

1.4.5.1 Starting Track Control by RAYTHEON Anschütz ECDIS

To activate Track Control mode from the RAYTHEON Anschütz ECDIS the NautoPilot® has to be in Heading Control mode and a planned track has to be available at the ECDIS. To activate Track Control mode, select Track Control from the menu Routes at the ECDIS. The user is then prompted to select a waypoint for either a Go- To- Way- point or a Return- To- Track maneuver. (For an NP5500 an approach radius in nautical miles suitable for the maneuver has to be entered.) If these selections are made and the button OK is clicked, the ECDIS activates the Track Control mode the NautoPilot. After Track Control mode is started, the parameter Rudder Limit is set to Max. The RAD/RoT- limits are obtained from the ECDIS.

Example:

The Autopilot is in the operating mode of Heading Control, a radius of 0.8 NM is adjusted and Radius is selected. The rudder limit is set to 10°. A route has been planned on the ECDIS, and the radius on the TO- WPT of the route has been planned to be 1.2 NM. The Autopilot has been initialized, the WPTs and the approach radius have been transmitted to the Autopilot. The approach radius is set to 0.3 NM. After change- over from heading control to track control, the radius (0.3 NM) is indicated. After reaching the first track (message NEW TRACK xxx°), the radius at the Autopilot displays 1.2 NM, i.e. the radius used for the next track change (see also section 2.3.3).

If the operating mode is changed back to heading control by actuation of the key Heading Control, the old value of 0.8 NM re- appears. Now the values can be varied on the operator unit again.

A similar situation occurs, if RoT is selected during heading control. On changing the operating mode from Heading Control to Track Control, a change- over from RoT to Radius is performed.

Example:

The Autopilot is in the operating mode of Heading Control, a rate of turn of 15°/min. has been adjusted and RoT is active. The rudder limit is set to 10°. A route has been planned on the ECDIS. The Autopilot has been initialized, the WPTs and the approach radius have been transmitted to the Autopilot. The approach radius is set to 0.3 NM. On actuating the key RAD/RoT, the radius (0.3 NM) is indicated on the display (see also section 2.3.3).

As soon as the operating mode is manually changed over from Track Control to Heading Control, RoT, 15°/min appears. The rudder limit is set to 10° again.

The following sections 1.4.5.1.1 and 1.4.5.1.2 describe 2 types of maneuvers for going to the planned track after starting Track Control.

The following section 1.4.5.1.1 describes the GO- TO- WAYPOINT maneuvers which bring the vessel directly to the TO- WPT, i.e. to the beginning of the track section between TO- WPT and NEXT- WPT. The FROM- WPT is not required for this kind of maneuvers and remains undefined.

The section 1.4.5.1.2 describes the RETURN- TO- TRACK maneuvers which bring the vessel to the track section between FROM- WPT and TO- WPT.

It depends on the user which of these 2 types is used.

Requirements for Track Control using the NP5100, NP5300, NP5400

Figure 12: Example for GO- TO- WAYPOINT Maneuver for NP5100, NP5300 and NP5400

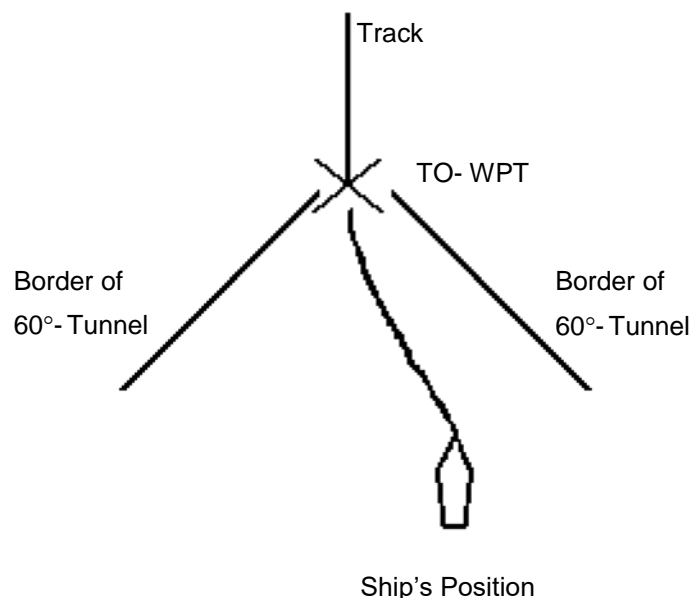

Note: Ship has to be inside a 60°- Tunnel heading towards the TO- Waypoint.

Requirements for Track Control using the NP5500

Figure 13: Example of Five Different GO- TO- WAYPOINT maneuvers depending on initial heading

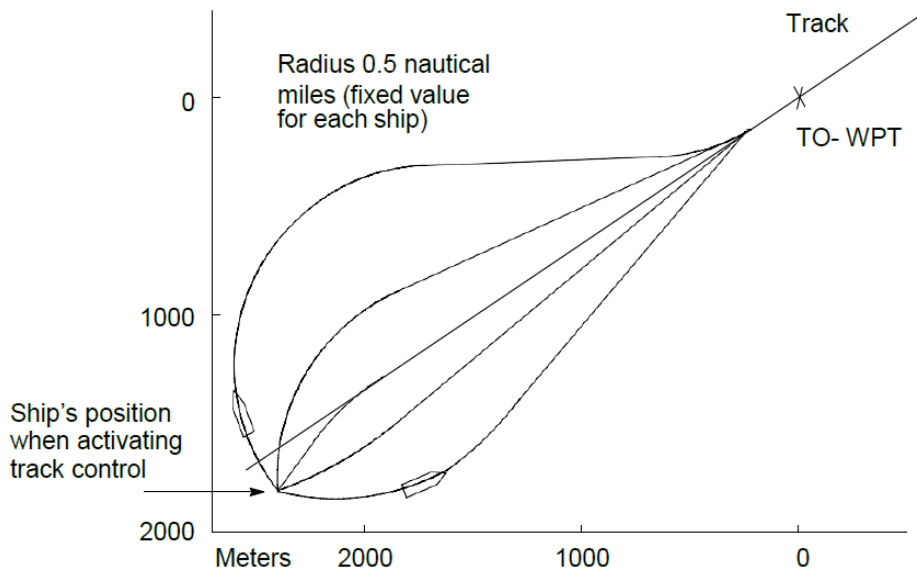
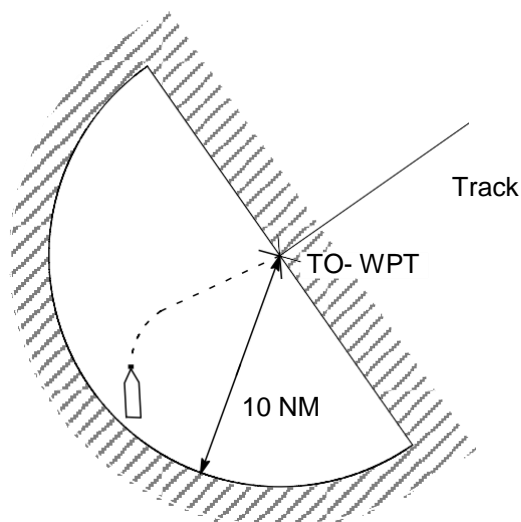
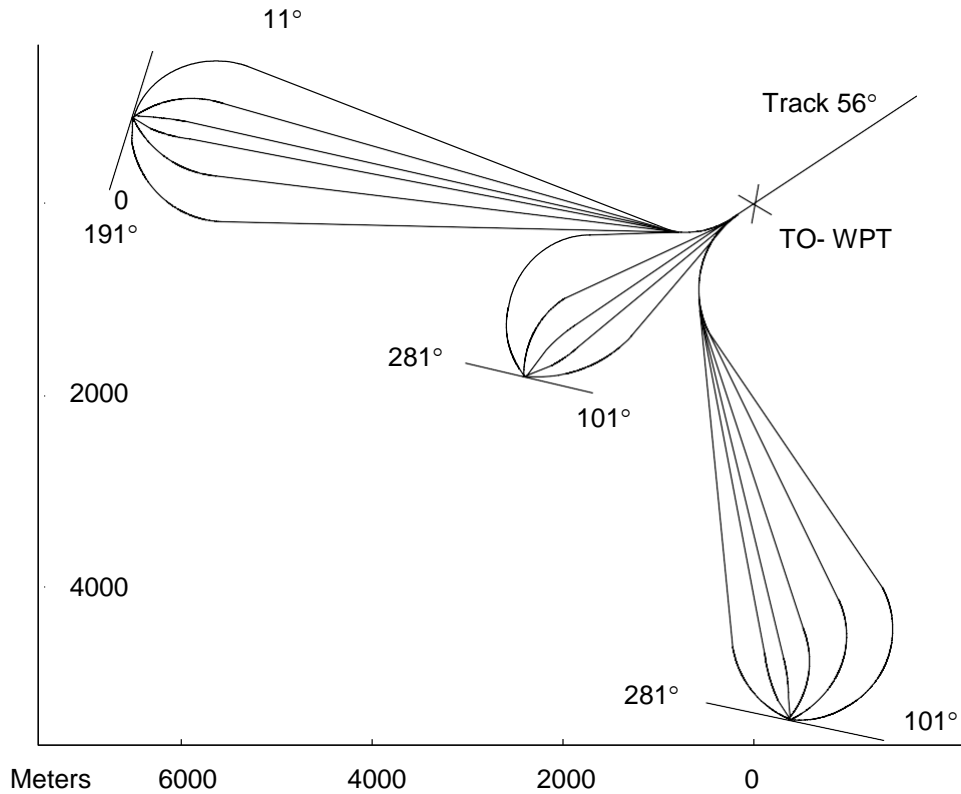

Figure 14: Geometrical Requirements of GO- TO- WAYPOINT maneuvers



A) The **initial position** must be before the track and less than 10 nautical miles away.



B) The **initial heading** must be between track course minus 45° and track course plus 135° if starting from the PORT side of the track and between track course minus 135° and track course plus 45° if starting from the STB side of the track.









1.4.5.1.1 Changing over to Track Control, GO- TO- WAYPOINT Maneuver

(See also Figure 12 and Figure 13)

Start Track Control at the ECDIS as GO- TO- WAYPOINT maneuver.

Note:

The following alert will be displayed on the ECDIS only for NP5100, NP5300 and NP5400 (also refer to ECDIS manual). For the NP5500 the alert will be displayed on the ECDIS and on the Autopilot, if the Autopilot is not part of an INS.

	Indications	Comment/Notes
<p>Starting the Track Control mode is possible only from the ECDIS (NP 5400 and NP 5500). The track controller (Autopilot) will check the geometrical constellation of ships position and the track. If the geometrical constellation of the ship's position, heading and planned track makes it impossible to reach the track, a warning (see section 7) appears for 15 s at the top bar of the display and the Autopilot does not switch over to Track Control.</p> <p>If the check is passed and the geometrical constellation admits to switch over to Track Control, Track Control is activated.</p>		
<p>An alert is displayed at the top bar of the display (see section 7).</p>		
	<p>Go To Waypoint </p>	<p>The LED ACK flashes. At the top bar of the display the message is displayed in long text.</p>
	<p>Go To Waypoint </p>	<p>Acknowledge the preselected track course by pressing the ACK key, the switching-over procedure to track control is started within the next 20 seconds. The LED ACK lights up automatically after 20 seconds and the message is no longer displayed.</p>
<p>The Autopilot starts the Track Control and displays the new track course.</p>		
<p>If the check of the geometrical constellation is negative, then the respective message (alert) is displayed at the top bar of the display.</p>		
	<p>Track Control Interrupted...   2 pulses</p>	<p>Heading Control mode is automatically activated. Refer to alert list, any Track Control Interrupted... alert.</p>
<p>After ACK the LED is alight constant and the text message is no longer displayed.</p>		

1.4.5.1.2 Changing over to Track Control RETURN- TO- TRACK Maneuver

Dependent on the use of the ECDIS, it is also possible to define a RETURN- TO- TRACK maneuver on the ECDIS and to transmit it to the Autopilot. Approaching a track is then performed like resuming Track Control after an interruption.

Note:

The following alert will be displayed on the ECDIS only for NP5100, NP5300 and NP5400 (also refer to ECDIS manual). For the NP5500 the alert will be displayed on the ECDIS and on the Autopilot, if the Autopilot is not part of an INS.







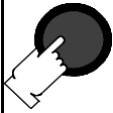

	Indications	Comment/Notes
<p>The track controller (Autopilot) will check the geometrical constellation of ships position and the track. If the geometrical constellation of the ship's position, heading and planned track makes it impossible to reach the track, a warning (see section 7) appears at the top bar of the display and the Autopilot does not switch over to Track Control.</p> <p>If the check is passed and the geometrical constellation admits to switch over to Track Control, Track Control is activated.</p> <p>An alert is displayed at the top bar of the display (see section 7).</p>		
	<p>New Track 070°</p> 	<p>The LED ACK flashes. At the top bar of the display the message is displayed in long text.</p>
	<p>Go To Waypoint</p> 	<p>Acknowledge the new track course by pressing the ACK key. The LED ACK lights up automatically after 20 seconds and the message is no longer displayed.</p>
<p>If the check of the geometrical constellation negative, then the respective message (alert) is displayed at the top bar of the display.</p>		
	<p>Track Control Interrupted...</p>  2 pulses 	<p>Heading mode is automatically activated. Refer to alert list, any Track Control Interrupted... alert.</p>
<p>After ACK the LED is alight constant and the text message is no longer displayed.</p>		

Figure 15: Changing over to Track Control - on transmitting a FROM- WPT by the ECDIS



NOTE :

In case of failure of the ECDIS during Track Control, automatic change- over from Track Control to Heading Control takes place. In that situation the response of the Autopilot is different. It is described under No or Invalid Status from ECDIS (see section 1.4.5.1.7.2).

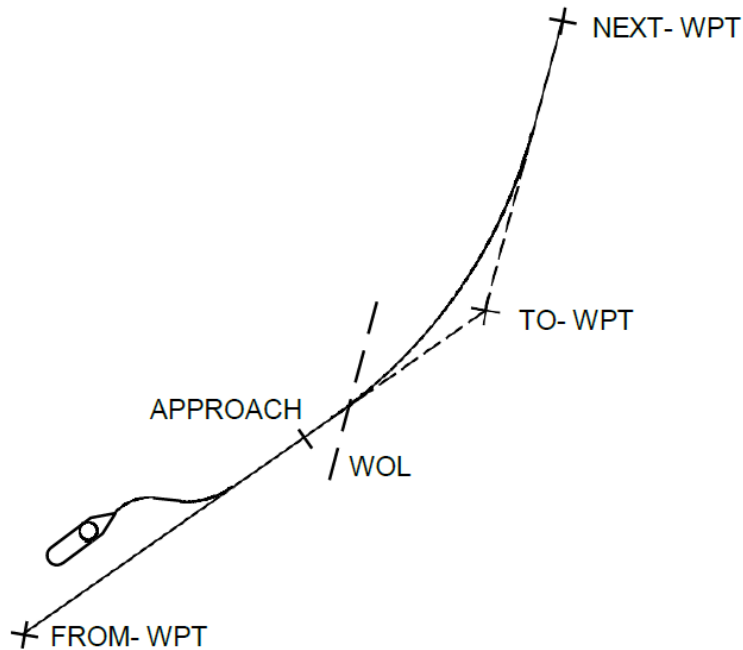
1.4.5.1.3 Track Change Maneuver (see Figure 16)

Attention!

The track change maneuvers are planned and checked on the ECDIS. No check within the Autopilot takes place. A limitation, however, is incorporated.

If a non- realizable small radius is transmitted to the Autopilot, this may lead to hard- over rudder positions!

On planning the routes, attention is to be paid to the fact that from the end of the radius of a track change maneuver to the beginning of the radius of the next track change maneuver at least 350 m are to be planned. This distance is required to bring the ship to the necessary rate of turn. The minimum distance between both radii depends on the vessel's maneuverability.





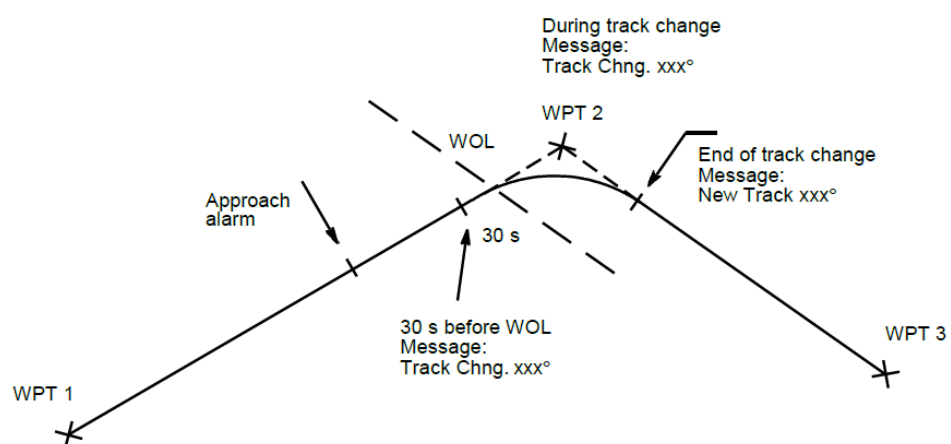







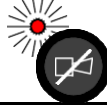

If this is not the case, the result may be that the planned radii cannot be realized. This will be signaled on the operator unit by the error message Track Ctrl. Interr. (Track Control Interrupted) and a continuous audible alarm (see section 1.4.5.1.7.4).

Figure 16: Procedure of the Track Change maneuver (Example)



The following alert will be displayed on the ECDIS only for NP5100, NP5300 and NP5400 (also refer to ECDIS manual). For the NP5500 the alert will be displayed on the ECDIS as well as on the Autopilot.

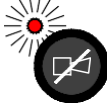



Procedure of the Track Change Maneuver

	Indications	Comment/Notes
An alert is displayed at the top bar of the display (see section 7).		
	<p style="text-align: center;">WOP IN x MIN OR LESS</p>  2 pulses 	<p>x minutes before the WOP. The approach time is transmitted from the ECDIS to the Autopilot. The LED ACK flashes. At the top bar of the display the message is displayed in long text.</p>
	<p style="text-align: center;">WOP IN x MIN</p>  	After acknowledgement the LED is alight constant and the message text changes to short text.
Please note: If this warning is not acknowledged it becomes an Alarm. With 3 pulses acoustical sound, red and blinking message bar and the below mentioned message about the 30 seconds- warning is dropped.		
An alert is displayed at the top bar of the display (see section 7).		
	<p style="text-align: center;">WOP IN 30 SECOND OR LESS</p>  2 pulses	30 seconds before the track change maneuver is started.
	<p style="text-align: center;">WOP IN 30 SECOND</p>  	After acknowledgement the LED is alight constant and the message text changes to short text.
Track change maneuver starting. An alert is displayed at the top bar of the display (see section 7).		
	<p style="text-align: center;">Changing Track xxx°</p> 	During the track change maneuver, the LED ACK is alight constant.
	<p style="text-align: center;">Changing Track xxx°</p>	Approach maneuver to a new track ended. An alert is displayed at the top bar of the display.
	<p style="text-align: center;">Chang. Track xxx°</p> 	As soon as the ship reaches the new track this message must be acknowledged.

Special alerts for the NP5500

Note:

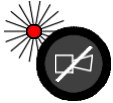
If the WPTs are very close together and if a long APPROACH time has been adjusted, it may happen that the APPROACH alarm of the following WPT appears already during the current track change maneuver:

	Indications	Comment/Notes
An alert is displayed at the top bar of the display (see section 7).		
	<div style="text-align: center;">  2 pulses  </div> <div style="text-align: center; background-color: #d4b85d; color: black; padding: 2px; font-weight: bold;">Approach NEXT- Waypoint</div>	
Acknowledge the alert.		
	<div style="text-align: center;">   </div> <div style="text-align: center; background-color: #d4b85d; color: black; padding: 2px; font-weight: bold;">App. NEXT- Wpt.</div>	After acknowledgement the short text is displayed and the LED is no longer alight.

Extreme case:

Figure 17: Extreme Case Example of a Track Change maneuver

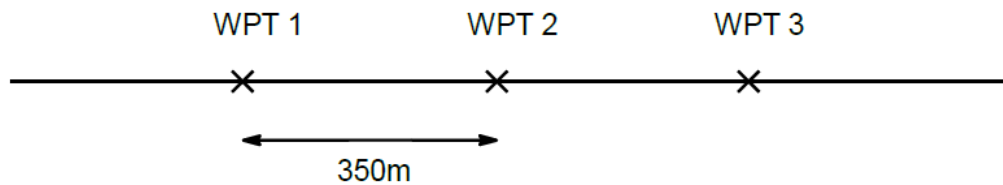

Attention is here to be paid to that the minimum distance between 2 successive radii have been defined to be 350 m and that, therefore, with a speed of approx. 20 kn the shortest approach time that may occur in this most unfavorable case is still approx. 70 s.

1.4.5.1.4 Interruption of Track Control

Interruption of Track Control is possible as follows:

- Change- over of the operating mode of Track Control to Heading Control on the operator unit of the Autopilot.
- Change- over of the operating mode of Track Control to manual control by switching over the operating mode on the steering mode selector.
- Activating the override tiller

- If the Track Control fails, it is automatically changed to Heading Control.
For more details in this case, refer to section 1.4.5.1.7.2.

Re- approaching the track is the same procedure as starting a new track !

1.4.5.1.5 Changing TO- WPT and NEXT- WPT without Interrupting Track Control

Figure 18: Changing TO- WPT and NEXT- WPT without Interrupting Track Control

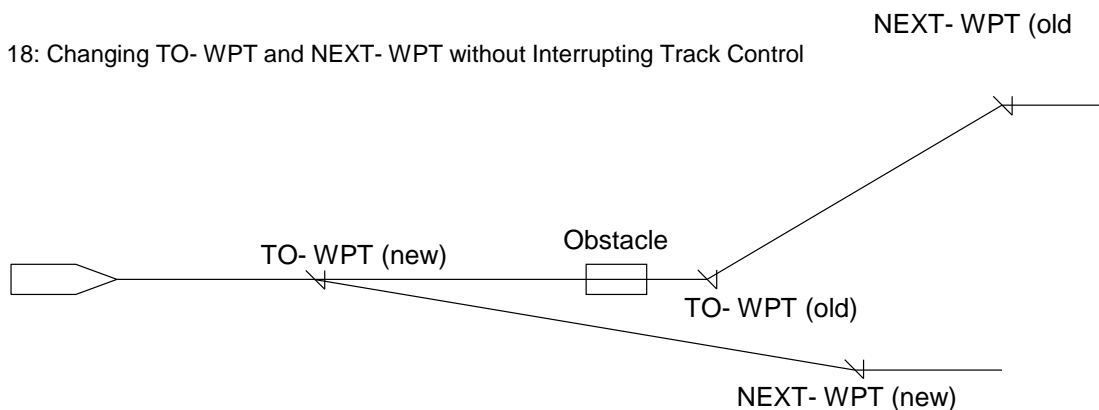





The Autopilot permits changing TO- WPT and NEXT- WPT without interrupting track control, if the track planning system (ECDIS) already supports this feature.

Consult your ECDIS manuals for further operating instructions on how to change the waypoints of the active route.











Special alerts for the NP5500

This procedure is indicated by messages at the top bar of the display:

Track change maneuver starting. An alert is displayed at the top bar of the display (see section 7).		
	<p>Changed Waypoints</p>  	
	 	<p>Should be acknowledged. If not, then the LED is no longer alight and the message text is no longer displayed.</p>

1.4.5.1.6 End of Track

Via marking the last track point at the ECDIS, the track controller (Autopilot) recognizes the end of a track.

	Indications	Comment/Notes
An alert is displayed at the top bar of the display (see section 6).		
	<p style="text-align: center;">Track End x min</p> <p style="text-align: center;"> 2 pulses </p>	x minutes left to the last track point.
Acknowledge the alert.		
	<p style="text-align: center;"> </p>	
An alert is displayed at the top bar of the display (see section 6).		
	<p style="text-align: center;">Track End Passed</p> <p style="text-align: center;">Change Steering Mode</p> <p style="text-align: center;">3 pulses  repeated every 7 seconds</p>	Last track point reached and passed. Both messages swapping.
Acknowledge the alert.		
	<p style="text-align: center;">Track End Passed</p> <p style="text-align: center;"> </p>	The alarm comes up every 7 seconds until having changed- over to another operating mode, e.g. Heading Control or manual control (tiller or steering mode selector switch).

Attention:

Before a mode change (e.g. Heading Control) is performed, the ship continues moving along the extended track with the operating mode Track Control!

1.4.5.1.7 Error Considerations

- No Position
- No or invalid Status
- No Heading (see section 7.3.2.1)
- Missing Waypoint
- Track control impossible.

ATTENTION:

If an error occurs during Track Control, the operating mode changes from Track Control to Heading Control.

As opposed to manual change-over from Track Control to Heading Control, the setting of the maneuver parameters might maintain as under Track Control.

I. e.:

On straight leg:

All values will be adopted from Heading Control mode. On curved path:



The radius planned for the next track change maneuver is maintained.

The rudder limit remains at Max.

Alert Check Settings" is displayed (see section 1.4.5.1.7.2).

1.4.5.1.7.1 No Position

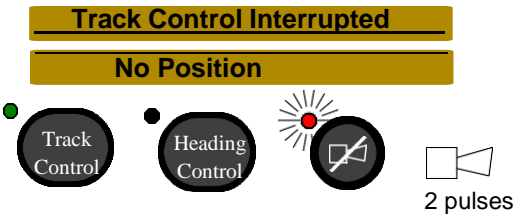
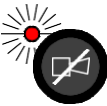

The Autopilot monitors the position interface. In the normal case, the position is transmitted to the Autopilot once per second. Should the position fail to come in for longer than approx. 5 seconds, the following alert appears at the top bar of the display (see section 7):

	Indications	Comment/Notes
An alert is displayed at the top bar of the display (see section 7).		
		<p>Both messages swapping. 2 acoustical pulses.</p> <p>The operating mode changes from Track Control to Heading Control.</p>
Acknowledge the alert.		
		<p>If the ship is at this moment on a track section and not in a track change maneuver, the heading is taken as the new set heading. As opposed to manual change-over from Track Control to Heading Control, the setting of the maneuver parameters might maintain as under Track Control.</p> <p>I. e.:</p> <p>On straight leg:</p> <ul style="list-style-type: none"> - All values will be adopted from Heading Control mode. <p>On curved path:</p> <ul style="list-style-type: none"> - The radius planned for the next track change maneuver is maintained. - The rudder limit remains at Max. - Alert Check Settings is displayed (see section 1.4.5.1.7.2). <p>If during automatic change-over from Track Control to Heading Control - the ship is in a track change maneuver, the track course of the next track section is taken as the new set heading. The radius planned for the current track change maneuver is taken as maneuver parameter.</p>

1.4.5.1.7.2 No or invalid Status from ECDIS

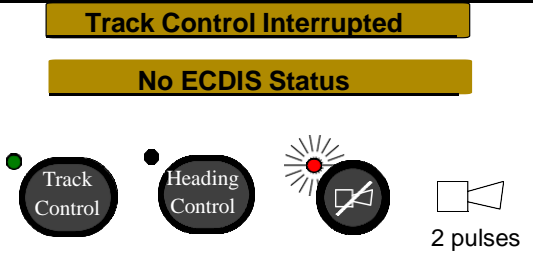

The Autopilot monitors the incoming status of the ECDIS. Should the status fail or be provided with the information that the ECDIS is not ready for operation,

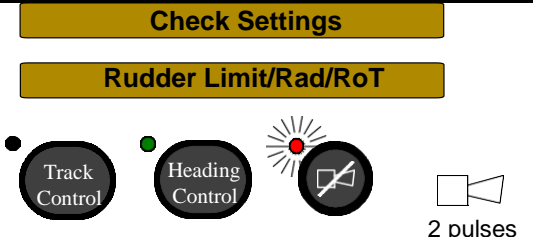
the following alert appears on the display:

	Indications	Comment/Notes
An alert is displayed at the top bar of the display (see section 7).		
		<p>Both messages swapping. 2 acoustical pulses.</p> <p>The operating mode changes from Track Control to Heading Control.</p>
Acknowledge the alert.		
		<p>If the ship is at this moment on a track section and not in a track change maneuver, actual heading is taken as the new set heading. As opposed to manual change- over from Track Control to Heading Control, the setting of the maneuver parameters might maintain as under Track Control.</p> <p>I. e.:</p> <p>On straight leg:</p> <ul style="list-style-type: none"> - All values will be adopted from Heading Control mode. <p>On curved path:</p> <ul style="list-style-type: none"> - The radius planned for the next track change maneuver is maintained. - The rudder limit remains at Max. - Alert Check Settings is displayed (see below). <p>If during automatic change- over from Track Control to Heading Control - the ship is in a track change maneuver, the track course of the next track section is taken as the new set course (preset heading). The radius planned for the current track change maneuver is taken as maneuver parameter.</p>
After the acknowledgement additional warning messages are displayed.		
		<p>Both messages swapping.</p> <p>After acknowledgement (or adjustment) of the Rudder Limit value and/or the Rad/RoT value no message is displayed and the ACK LED is no longer alight.</p> <p>This message will be shown during mode change on curved track only.</p>

1.4.5.1.7.3 Missing Waypoint (NP5500 only)

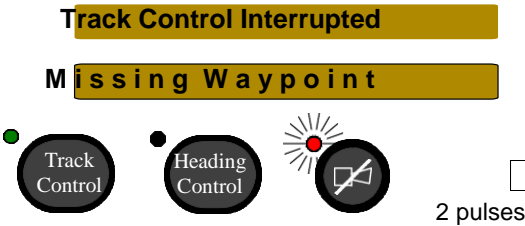
Should disturbances occur on the interface between ECDIS and Autopilot, and the Auto- pilot does not receive WPTs, this will be indicated on the operator unit at the end of the track change maneuver. The following alert appears on the display:

	Indications	Comment/Notes
An alert is displayed at the top bar of the display (see section 7).		
		<p>Both messages swapping. 2 acoustical pulses.</p> <p>The operating mode changes from Track Control to Heading Control.</p>
Acknowledge the warning		
		<p>The actual heading is taken as the new set heading. As opposed to manual change-over from Track Control to Heading Control, the setting of the maneuver parameters might maintain as under Track Control. I. e.:</p> <p>On straight leg:</p> <ul style="list-style-type: none"> - All values will be adopted from Heading Control mode. <p>On curved path:</p> <ul style="list-style-type: none"> - The radius planned for the next track change maneuver is maintained. - The rudder limit remains at Max. - Alert Check Settings is displayed (see section 1.4.5.1.7.2).

1.4.5.1.7.4 Track Control Impossible (NP5500 only)

1. On activating Track Control (see Figure 18 and Figure 19)
 - If the ship (when the Track Control is activated) is already too close to the TO-WPT and, for geometrical reasons, the intended maneuver cannot be realized any more.

Figure 19: Intended RETURN- TO- TRACK maneuver impossible, Ship too Close to the TO- WPT

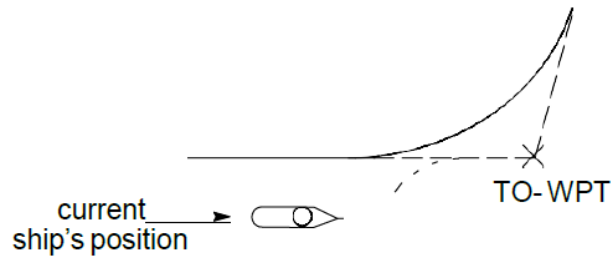

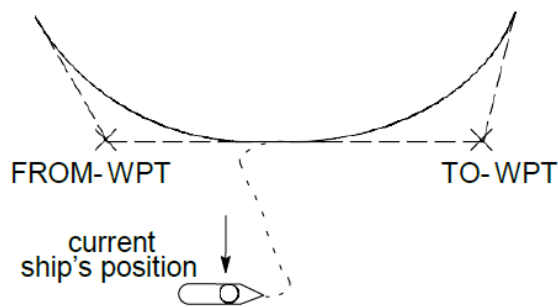

- If (when Track Control is activated) the distance of the current ship's position to the track is greater than the distance between FROM- WPT and TO- WPT or greater than 10 nautical miles.

Figure 20: Track Control impossible, Distance to the Track too large





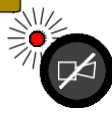





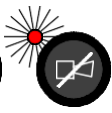

The following alert appears at the top bar of the display (see section 7) of the Autopilot:

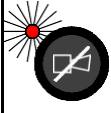
	Indications	Comment/Notes
	<p>Track Control Interrupted</p> <p>Way Point too far away</p> <p> 2 pulses </p>	<p>Both messages swapping. After acknowledgement no message is displayed. Autopilot stays in mode Heading Control.</p> <p>Recommended action: Reduce the distance and try it again.</p>

2. During a long active voyage in the operating mode of Track Control the Autopilot received WPTs whose radii are closer together than 350 m or the

difference of the track courses is $>135^\circ$.

	Indications	Comment/Notes
An alert is displayed at the top bar of the display (see section 7).		
	<p style="text-align: center;">Track Control Interrupted</p> <p style="text-align: center;">Distance TO/NEXT- Waypoint too short</p> <p style="text-align: center;">or</p> <p style="text-align: center;">Change Angle too big</p> <div style="display: flex; justify-content: space-around; align-items: center;"> <div style="text-align: center;">  Track Control </div> <div style="text-align: center;">  Heading Control </div> <div style="text-align: center;">  </div> <div style="text-align: center;">  2 pulses </div> </div>	<p>Both messages swapping. 2 acoustical pulses.</p> <p>The operating mode changes from Track Control to Heading Control.</p>
Acknowledge the alert.		
	<div style="text-align: center;">  </div> <div style="display: flex; justify-content: space-around; align-items: center;"> <div style="text-align: center;">  Track Control </div> <div style="text-align: center;">  Heading Control </div> <div style="text-align: center;">  </div> <div style="text-align: center;">  </div> </div>	<p>The operating mode changes from Track Control to Heading Control. The track course becomes set course (preset heading). As opposed to manual change-over from Track Control to Heading Control, the setting of the maneuver parameters might maintain as under Track Control. I. e.:</p> <p>On straight leg:</p> <ul style="list-style-type: none"> - All values will be adopted from Heading Control mode. <p>On curved path:</p> <ul style="list-style-type: none"> - The radius planned for the next track change maneuver is maintained. - The rudder limit remains at Max. - Alert Check Settings is displayed (see section 1.4.5.1.7.2). <p>If during automatic change-over from Track Control to Heading Control - the ship is in a track change maneuver, the track course of the next track section is taken as the new set course (preset heading). The radius planned for the current track change maneuver is taken as maneuver parameter.</p>

1.4.6 Operation mode Waypoint Steering

Important Note:

Please refer to chapter 4.5.2 before using waypoint steering mode! Waypoint steering is possible with NP 5100 or NP5300 only!

In waypoint steering mode the route - consisting of 2 or more waypoints - is planned on a GPS, chart plotter or equivalent navigation system. NP5000 receives only the data from the navigation system in order to steer the vessel on a certain track. The operator must have a good knowledge of the navigation system in use as this system controls the autopilot with regards to heading alterations, track changes and the corresponding alert philosophy.

The operator should closely monitor the progress when sailing on a route. In case of deviations from the route or any uncertainty the operator should switch to Auto and use the heading control function.

Starting Waypoint Steering mode in combination with GPS, chart plotter or equivalent navigation system

When the connected navigational system starts transmitting a valid APB- telegram (according to IEC 61162- 1) the waypoint steering mode can be activated by activating the Track button on the NP5000 operator unit. Make sure that the relevant parameters, such as rudder limit, radius or RoT are adjusted according to the planned route.

1.4.7 Manual

Standalone application: The mode Manual is not for Autopilot in a Standalone application. It will never be displayed in a Standalone application.

AS application: The steering switch is in position HAND.

1.4.8 Override

In general:

This mode is indicated (at the NautoPilot® Operator Unit) when a manual steering element (steering control unit) with an override function interrupts a control mode of the Autopilot.

This steering element can be a handwheel, a FU Tiller or an NFU Tiller.

To interrupt an Autopilot control mode a steering element must be configured for this function before.

If a steering element interrupts an Autopilot control mode, it is displayed with Override at the top right corner of the Autopilot display and the NautoPilot® Operator Unit is inactive.

For the activation of an Override mode an NFU Tiller must have a short contact to any direction and a FU Tiller or handwheel must be moved approx. 2° off the current position.

For AS application:

For deactivation of an Override mode the Heading button at the NautoPilot® Operator Unit must be pressed

or

at an Override Signal Unit (or devices with a similar function) the Autopilot button must be pressed.



Please note:

After deactivation of an override mode, the Heading Control mode at the Autopilot is automatically selected.



Caution!

It is advisable to check the actual rudder angle and the actual heading before switch over to Heading Control mode (actual heading → set heading).

2 Operation

2.1 Operation elements at the NautoPilot® Operator Unit

Figure 21: NautoPilot® Operator Unit (operation elements)

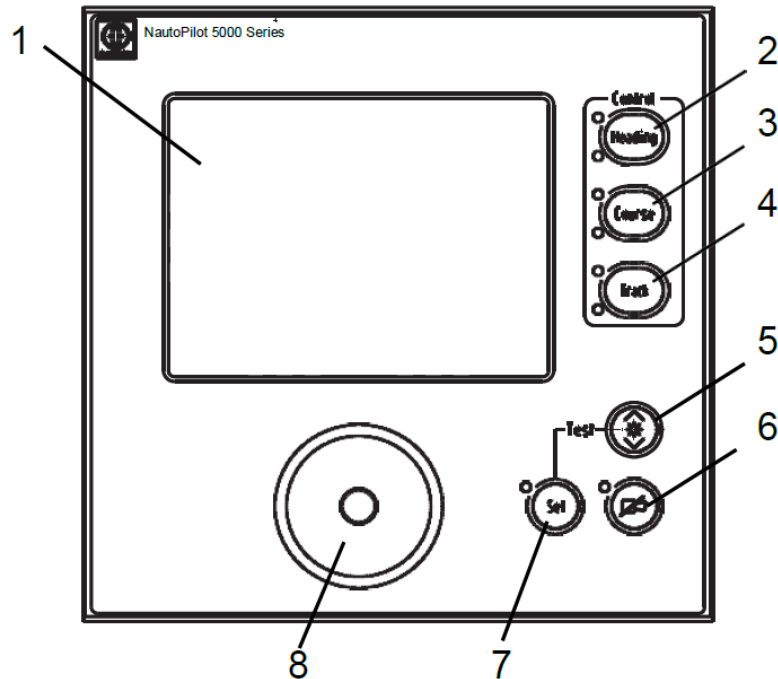

Table 3 NautoPilot® Operator Unit (operation elements)

Pos.	Designation	Remarks
Figure 20/1	Touchscreen	For the display of data and operation of the Autopilot via soft- keys.

Figure 20/2	HEADING button with 2 LEDs	<p>Activates Heading Control mode. LED (upper, green) indicates the selected steering mode. LED (lower, yellow) indicates:</p> <ul style="list-style-type: none"> - Selected steering mode, but NautoPilot® Operation Unit is inactive (control from a second NautoPilot® Operator Unit). The inactive NautoPilot® operator Unit serves as a display only (OU Display is displayed at the top right corner). -- AS application: Standby is displayed at the top right corner; the Autopilot can be activated by pressing the button Heading. -- Standalone application: Autopilot cannot be activated. A switching over of the Main Steering Switch to AUTO the lower LED is off and the upper LED is alight (steering mode is Heading Control).
Pos.	Designation	Remarks
Figure 20/3	COURSE button with 2 LEDs	<p>Activates Course Control mode. LED (upper, green) indicates the selected steering mode. LED (lower, yellow) indicates selected steering mode, but NautoPilot® Operation Unit is inactive (control from a second NautoPilot® Operator Unit).</p>
Figure 20/4	Track button with 2 LEDs	<p>Activates Track Control mode. LED (upper, green) indicates the selected steering mode. LED (lower, yellow) indicates selected steering mode, but NautoPilot® Operation Unit is inactive (control from a second NautoPilot® Operator Unit).</p> <p>Activation of Track Control at the Autopilot is possible with a generic ECDIS only. Furthermore, it is not possible with an NP5500. If Track Control cannot be activated the Autopilot, an error message will be displayed.</p>

Figure 20/5	DIM button	Adjusts brightness of illumination and display. See also section 6.3 for dimming active/inactive NautoPilot® Operator Units.
Figure 20/6	ACK button with LED (red)	Acknowledges alarm or status messages. LED (red blinking) indicates the first occurrence of an alarm or status message (blinking) or that an acknowledged alarm or status message is still present (constant glow). In order to avoid unintended acknowledgement of a new incoming alert, the push button is deactivated for 1 second after receiving a new alert.
Figure 20/7	SET button with LED (yellow)	Sets changed parameters or adjusted values. LED blinks to request the pressing of this button.
Figure 20/5 and 7	DIM and SET buttons	Activates the Test function if both buttons are pressed simultaneously. An interactive test (for the operator of the NautoPilot® Operator Unit) is performed to check the operating elements and the touch-screen and its function.
Figure 20/8	Combined rotary knob/button	Presets a heading and activates adjusted set heading value.
Information about the changeover of NautoPilot® Operator Units, see section 6.3. Information on the test function, see section 2.3.7 Information on the alarm/status message handling, see section 7.		

2.2 Structure of parameter and adjustments

Figure 22: Structure to adjust parameters and values

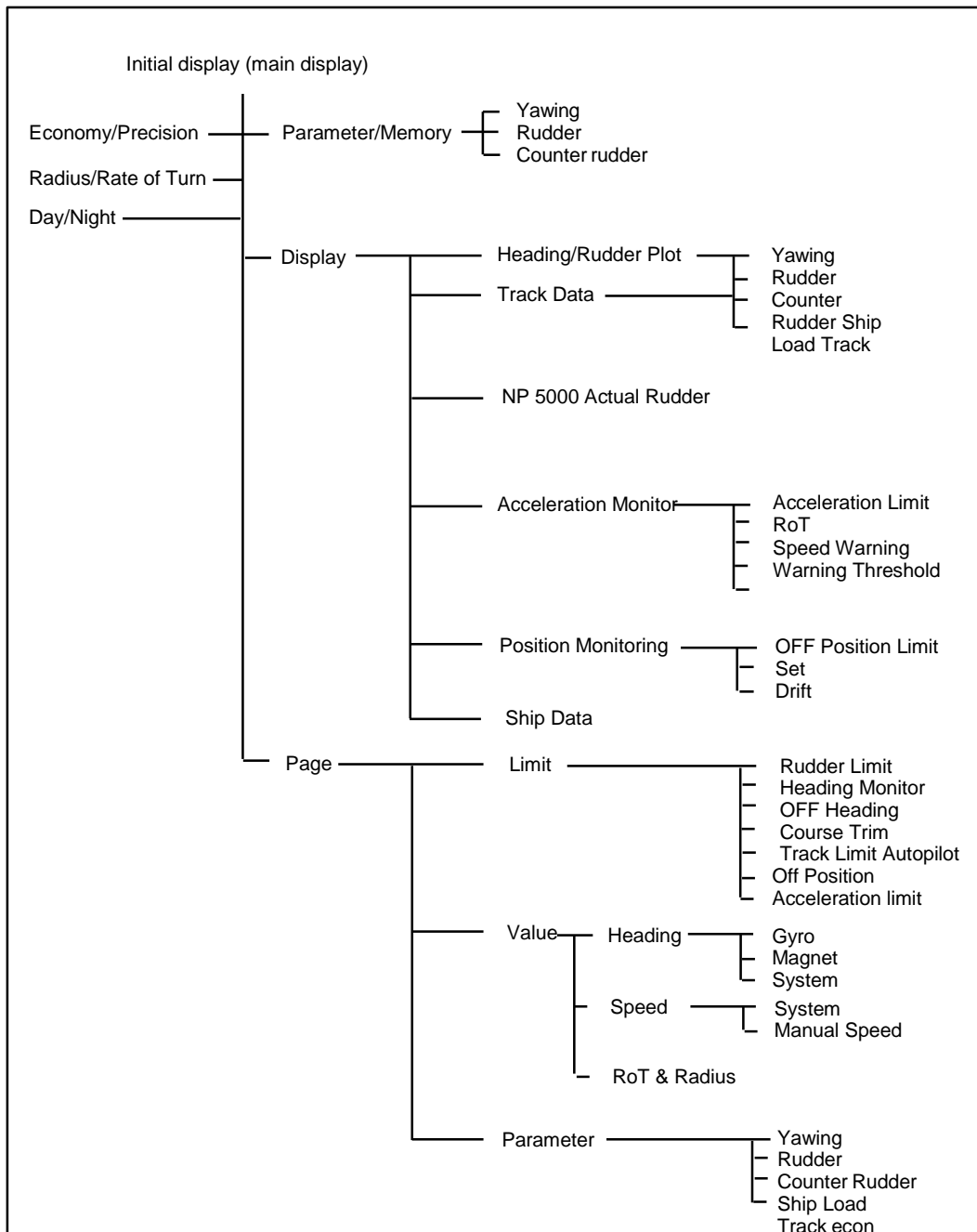

2.3 Touchscreen functions / adjustments

After switching on the NautoPilot® Operator Unit, the display below appears.

Figure 23: First display (after switching ON the NautoPilot® Operator Unit)

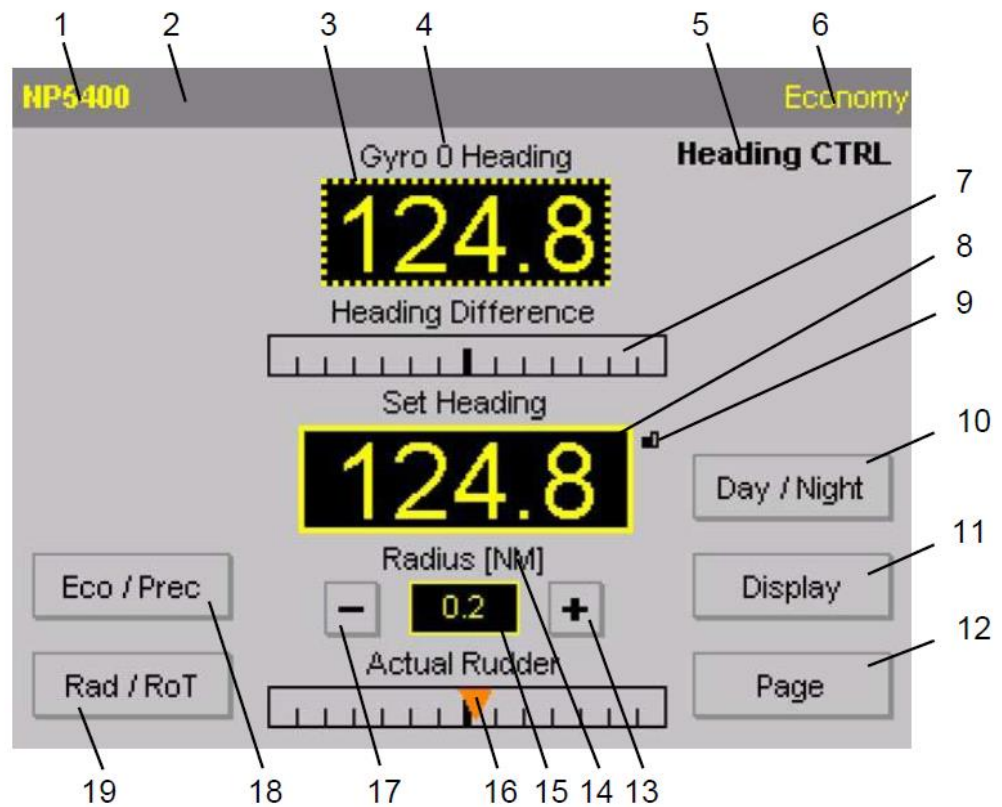

Fields with grey lined rectangles are softkeys. By touching these softkeys other/additional functions are called up/displayed.

Table 4 Operating and monitoring elements of initial display after turning-on

	Function
Figure 22/1	Indicates the type of NautoPilot®: NP 5100, NP 5300, NP 5400 or NP 5500.
Figure 22/2	Alert and status bar (top bar of the display). Alerts and status information are displayed alphanumerical. They must be acknowledged. For more information see the NautoPilot® Operator Unit Service Manual.
Figure 22/3	Indicates the actual heading value from the selected heading source.
Figure 22/4	Indicates the selected heading source. Possible heading sources are: -- Gyro -- GPS -- Mag Uncorrected Magnetic Heading (magnetic heading without correction values for variation/deviation)
Figure 22/5	Indicates the operation mode / status of the Autopilot: Heading Ctrl, see also section 1.4.3 (- all types of NautoPilot® -) or Course Ctrl, see also section 1.4.4 (- not for NautoPilot® 5100 -) or Track Ctrl, see also section 1.4.5 (- all types of NautoPilot® -) or Override, see also section 1.4.8 (- all types of NautoPilot® -) or Manual, see also section 1.4.7 (- all types of NautoPilot® -) or Standby, see also section 1.4.2 (- all types of NautoPilot® -) or --- -- -- -- -- , see section 1.4.2 (- all types of NautoPilot® -)
Figure 22/6	Indicates selected mode Economy or Precision, selectable via the soft- key Eco/Prec (Figure 22/18) Not for NP 5100 or if the Adaptive mode is not configured. Otherwise the softkey is designated as Para/Mem.
Figure 22/7	Indicates the difference between actual heading and set heading in a tendency bar structure. For Course Control mode this bar is designated as Distance to Course line. See also section 2.3.1. For Track Control mode this display is designated as Cross Track Error.
Figure 22/8	Indicates the set heading value from a manual steering control unit (Handwheel/Tiller/Rotary knob). This display also acts as a softkey; by touching it, the display resolution is changed and the small icon (Figure 22/9) changes. For Course Control mode this display is designated as Set Course Over Ground. For Track Control mode it is designated as Track Course.

Figure 22/9	Resolution icon. Softkey to switch the resolution of the set heading value between 1° and 1/10°.
Figure 22/10	Softkey for switching between night and day modes.
Figure 22/11	Softkey for selecting displays with other content: <ul style="list-style-type: none"> - HDG/Rudder plot: displays heading versus rudder position in a recorded graphic mode. - Track Data (- not in Heading Control -): displays a track in a recorded graphic mode. - NP 5000 Actual Rudder: displays the actual rudder position in a graphic mode. - Acceleration Monitor: displays actual acceleration values in an alphanumeric display (if configured). - Position Monitoring: displays all available satellites for position calculation in a graphical mode (if configured). - Ship Data: displays all essential ship data (set during configuration).
Figure 22/12	Softkey for showing and editing general settings for control functions of the Autopilot: <ul style="list-style-type: none"> - Limits - Values - Parameter (independent from the configured values but limited by those values)
Figure 22/13	Softkey for changing the value for a heading change performed either by a rate of turn function or by a radius function to a higher value.
Figure 22/14	Alphanumerical information about the mode for heading changes (selectable by the softkey Rad/RoT (Figure 22/19))
Figure 22/15	Display that shows the rate of turn or the radius value for a heading change.
Figure 22/16	Bar that indicates the actual rudder position.
Figure 22/17	Softkey for changing the value for a heading change performed either by a rate of turn function or by a radius function to a lower value. Changed value must be acknowledged (SET).
Figure 22/18	Softkey for switching between Economy mode and Precision mode (- not for NP 5100 -).
Figure 22/19	Softkey for switching between radius controlled heading changes and rate of turn controlled heading changes.

2.3.1 Tendency Bar

This bar shows the tendency of data displayed above the bar.
There are 3 different forms to display the information:

Figure 24: Tendency bar

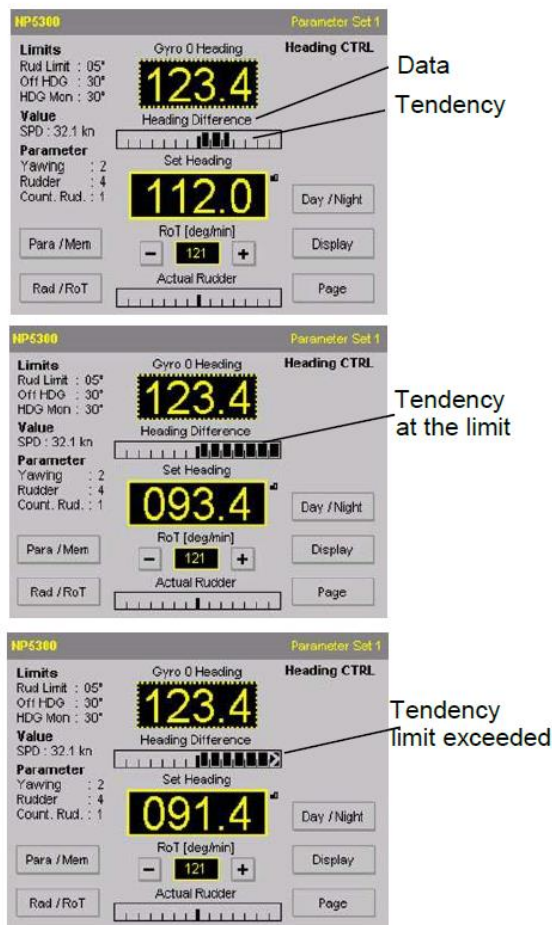

2.3.2 Switching between night and day displays

Figure 25: First display (after switching ON the NautoPilot® Operator Unit in night mode, black/white)

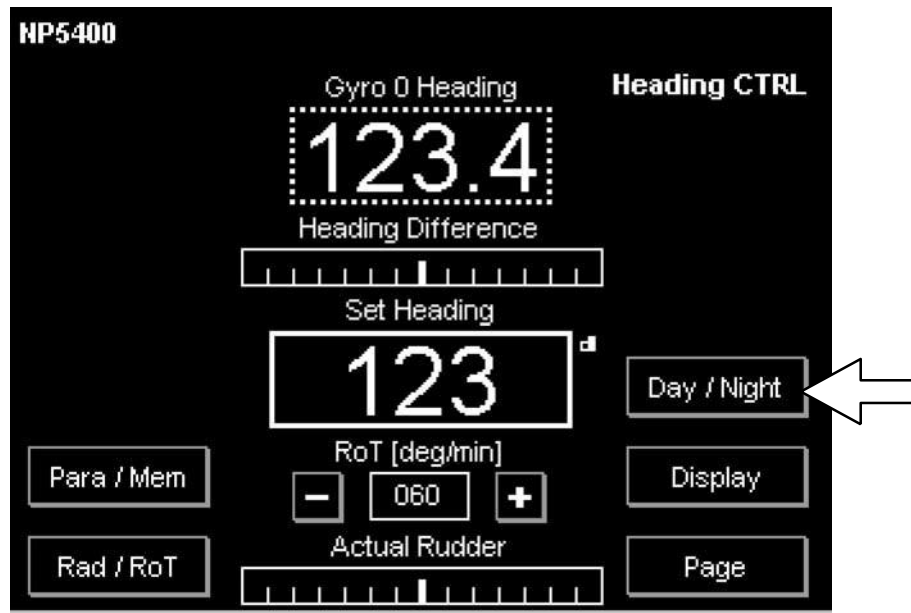

Use this softkey (see Figure 24) to switch between preset day or night displays (see configuration, Service Manual).

2.3.3 Switching and Adjusting Rad/RoT

Figure 26: First Display (heading changes with RoT is selected).

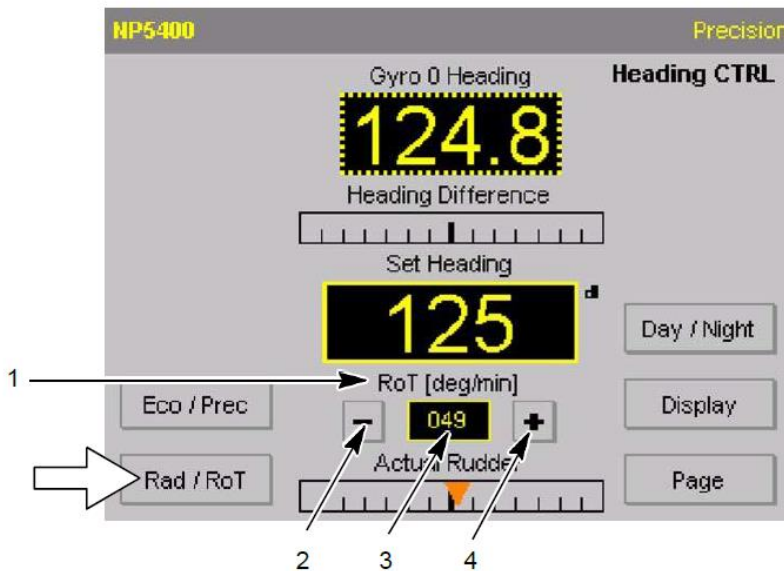

Heading changes can be performed with a Rate of Turn (RoT) limit or with a limited radius.

The respective mode can be selected with the Rad/RoT softkey. The currently selected mode is displayed (Figure 25, Pos. 1).

Use the - and + softkeys (Figure 25, Pos. 2 and 4) to set the value RoT or the value of the radius.

Each change of value must be acknowledged by pressing the SET button, at which point a small icon is displayed communicating that this change must be acknowledged. Hold the - or + softkey to perform a faster change of value

It is not possible to set one of the values to zero.

Value range for RoT: 005°/min to 500°/min (in increments of 1°/min).

Value range for Rad :0.1 NM (nautical mile) to 5.0 NM (in increments of 0.1 NM).

Note:

Rad/RoT is not adjustable in mode Track Control with RAYTHEON Anschütz ECDIS.

2.3.4 Using and switching between Economy and Precision mode (not for NP 5100)

Figure 27: Initial Display (Eco/Prec switchover)

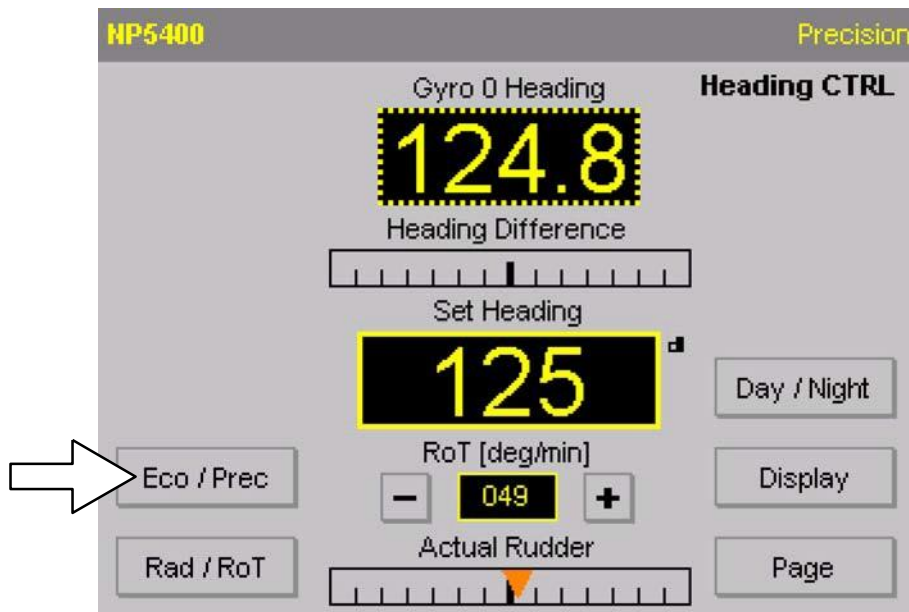

In Economy mode a low rudder activity is selected, in Precision a higher rudder activity is selected.

The selected mode is displayed in the top bar.

Please note:

It is advisable not to set Economy mode during passages through restricted areas, channels, waterways or harbors.

With switching into Economy mode, the rudder activities (movements) are reduced.

Switching into Precision mode the controller operates at a higher sensitivity to the heading difference, i.e. higher rudder activity.

Using Economy mode reduces fuel consumption and heading accuracy.

2.3.5 Displays for additional information and records

Figure 28: Switching to display selection

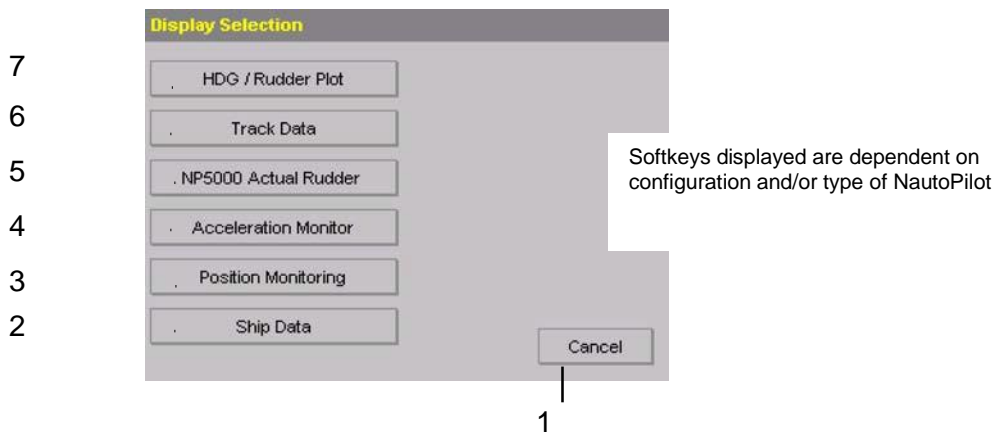
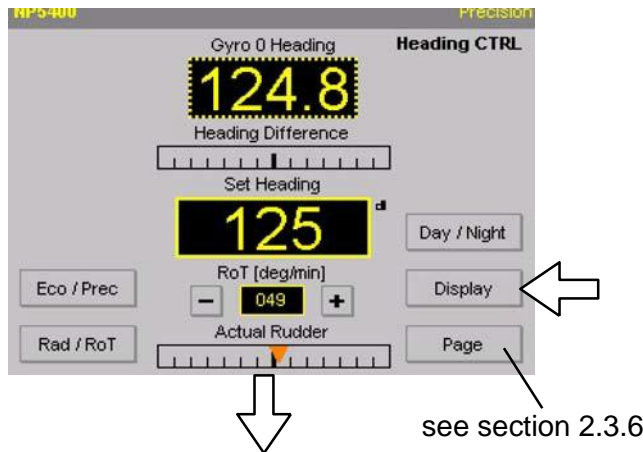

Table 5 Softkeys for Display Selection

	Function
Figure 27/1	Softkey Cancel for switching back to the initial display.
Figure 27/2	Softkey Ship Data, see section 2.3.5.6.
Figure 27/3	Softkey Position Monitoring, see section 2.3.5.5.
Figure 27/4	Softkey Acceleration Monitor, see section 2.3.5.4.
Figure 27/5	Softkey NP 5000 Actual Rudder, see section 2.3.5.3.
Figure 27/6	Softkey Track Data, see section 2.3.5.2.
Figure 27/7	Softkey HDG/Rudder Plot, see section 2.3.5.1.

2.3.5.1 HDG/Rudder Plot display

Figure 29: Displays for HDG /Rudder Plot

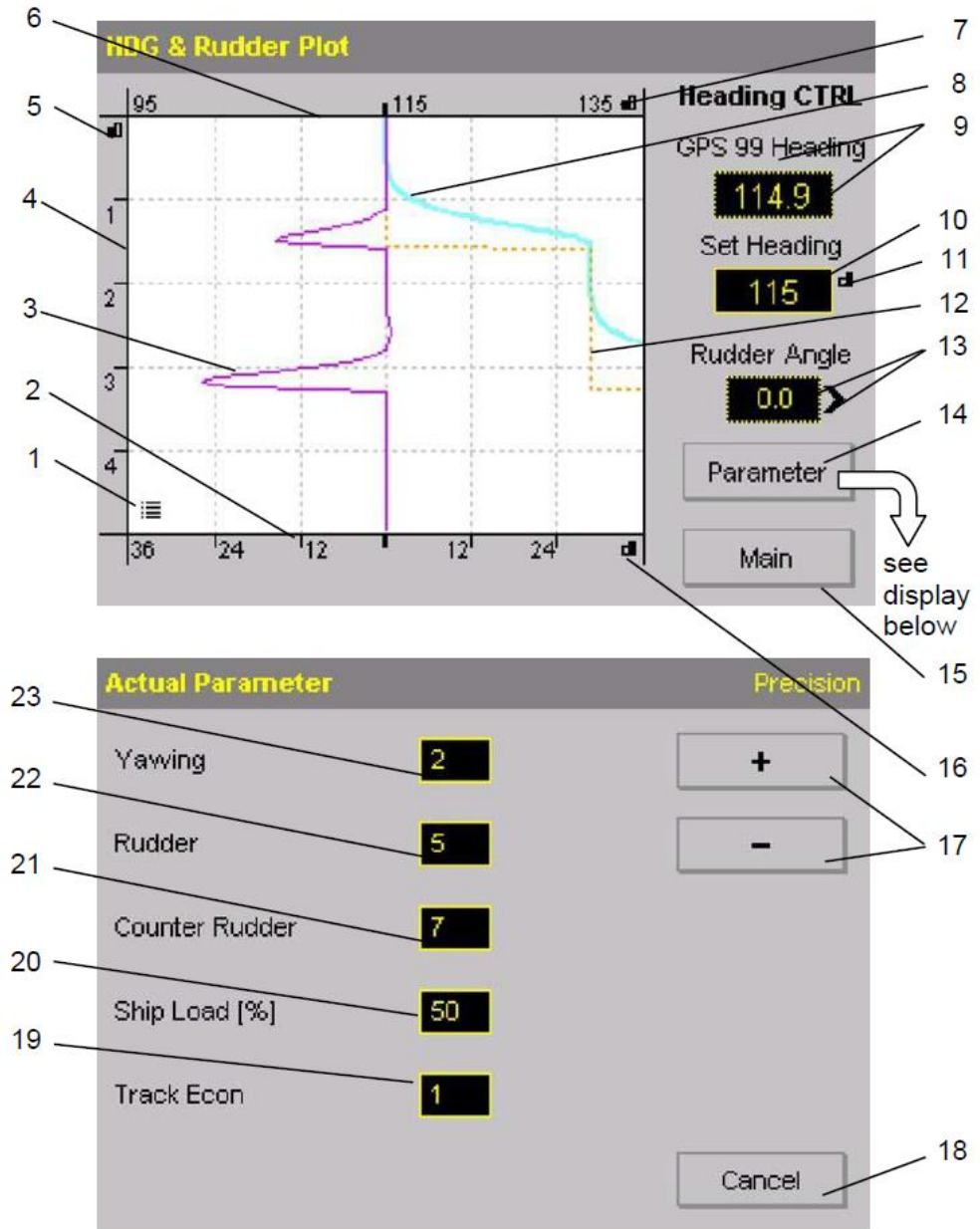

Figure 30: Example of a SET request after a parameter has been changed

This display in Figure 28 shows numerical and graphical recorded information on:

- Actual heading
- Set heading or Set COG or Track Course
(depends on selected control mode)
- Rudder position angle
- Current operating mode at the Autopilot which is still active.



Table 6 Softkeys for HDG/Rudder Plot Display

	Function
Figure 28/1	Touch- icon, displays a legend for the recorded information.
Figure 28/2	Axis for recorded rudder angle [deg].
Figure 28/3	The rudder position angle is displayed as a magenta colored graph.
Figure 28/4	Time axis for records [min].
Figure 28/5	Touch- icon, toggles resolution for the time axis 5 min / 20 min.
Figure 28/6	Axis for recorded current heading.
Figure 28/7	Touch- icon, toggles resolution for the heading axis +/- 20 deg / +/- 60 deg.
Figure 28/8	The actual heading is displayed as a blue graph.
Figure 28/9	Information regarding heading source and actual heading value.
Figure 28/10	Set heading value. For Course Control this display is designated as Presel. COG (Preselected Course Over Ground) after turning the rotary knob, Set COG after releasing the knob. For Track Control this display is designated as Track Course. For Heading Control this display is designated as Set Heading.
Figure 28/11	Touch- icon, toggles resolution for the set heading value.
Figure 28/12	Set Heading is displayed by an orange dotted line.
Figure 28/13	Rudder angle value with an arrow indicating the rudder direction.
Figure 28/14	Softkey, switches to the Actual Parameter display.
Figure 28/15	Softkey, switches to the main (initial) display.
Figure 28/16	Touch- icon, toggles resolution for the rudder angle axis +/- 8 deg / +/- 16 deg.

	Function
Figure 28/17	Softkeys for changing selected rudder parameters. Changes must be acknowledged with SET (a small icon is displayed after a change has been made, see Figure 29).
Figure 28/18	Softkey for switching back to the previous display, without a transfer of changed values.
Figure 28/19	Softkey for changing/entering the Track Econ parameter to influence rudder activity (see section 1.3.8).
Figure 28/20	For Adaptive mode only and not for NP 5100. Softkey for changing/entering the ship load condition parameter (see also section 1.3.4). Value range: 10% to 100% (in increments of 10%). Use the + and- softkeys to make a change. Changes must be acknowledged with SET (a small icon is displayed after a change has been made, see Figure 29).
Figure 28/21	Softkey for changing/entering the counter rudder parameter (see also section 1.3.3). Value range: 0 to 9 (in increments of 1). Use the + and- softkeys to make a change. Changes must be acknowledged with SET (a small icon is displayed after a change has been made, see Figure 29).
Figure 28/22	Softkey for changing/entering the rudder parameter (see also section 1.3.2). Value range: 1 to 9 (in increments of 1). Use the + and- softkeys to make a change. Changes must be acknowledged with SET (a small icon is displayed after a change has been made, see Figure 29).
Figure 28/23	Softkey for changing/entering the yawing parameter (see also section 1.3.1). Value range: 1 to 6 (in increments of 1). Use the + and- softkeys to make a change. Changes must be acknowledged with SET (a small icon is displayed after a change has been made, see Figure 29).

2.3.5.2 Track Data display

This display shows numerical and graphical recorded information on:

- Actual heading
- Set COG or Track Course
- Distance to course line or Cross Track Error
 (depends on selected control mode)
- Current operating mode at the Autopilot which is still active.

Figure 31: Displays for Track Data

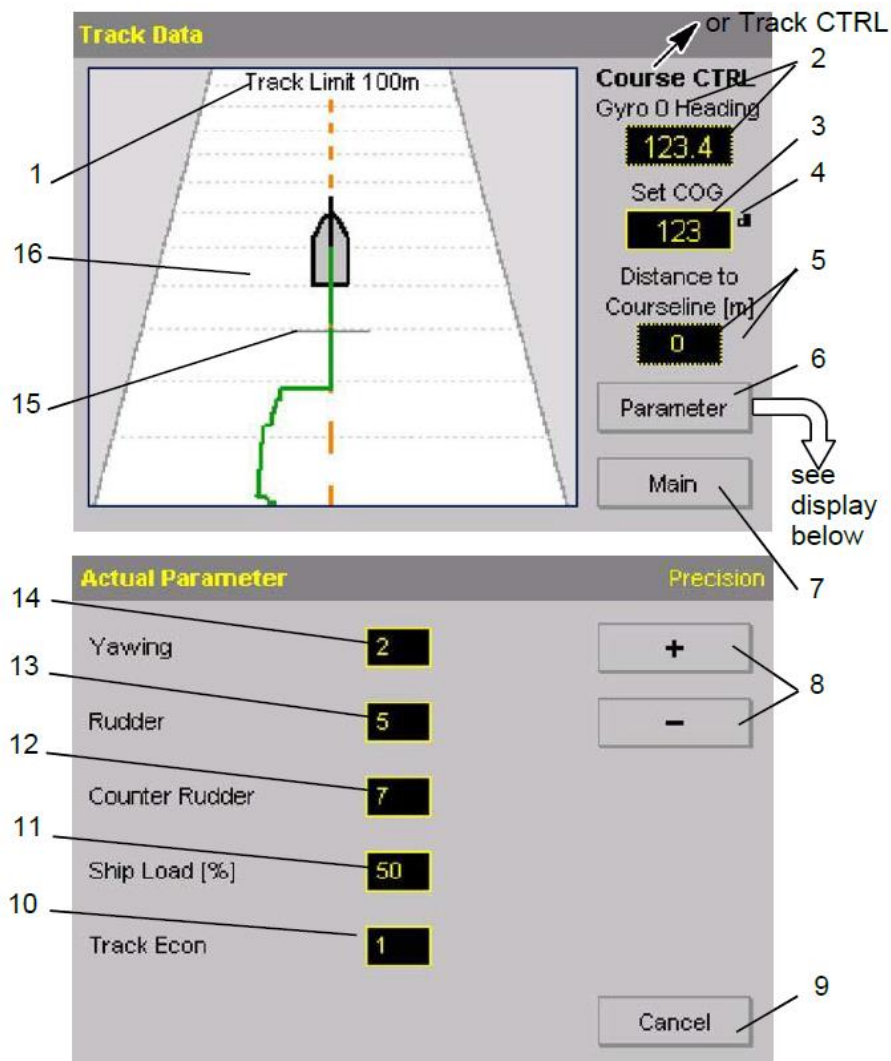

Furthermore, a graphic record shows the track, its configured max. distance, the course- line, the ship itself and the course to steer for the course line. Parameter settings will change the same parameters which can be set with the Page function (see section 2.3.6).

Figure 32: Example of a request to press SET after a parameter has been changed



Table 7 Softkeys for Track Data Display

	Function
Figure 30/1	Information about the track. Its width is 100 m to each side of the track (in the shown example).
Figure 30/2	Information on heading source and actual heading value.
Figure 30/3	Set heading value. For Course Control this display is designated as Presel.COG (Preselected Course Over Ground) after turning the rotary knob, Set COG after releasing the knob. For Track Control this display is designated as Track Course. For Heading Control this display is designated as Set Heading.
Figure 30/4	Touch- icon, toggles resolution for the respective value.
Figure 30/5	Numerical display for the distance to the course line (track) (or Cross Track Error) in meters, an arrow next to this display shows the direction of the distance from the course line (or Cross Track Error).
Figure 30/6	Softkey for switching to the Actual Parameter display.
Figure 30/7	Softkey for switching to the main (initial) display.
Figure 30/8	Softkeys for changing the selected parameters. Changes must be acknowledged with SET (a small icon is displayed after a change has been made).
Figure 30/9	Softkey for switching back to the previous display, without a transfer of changed values.
Figure 30/10	Softkey for changing/entering the Track Econ parameter to influence rudder activity (see section 1.3.8).

Figure 30/11	<p>For Adaptive mode only and not for NP 5100.</p> <p>Softkey for changing/entering the ship load condition parameter (see also section 1.3.4). Value range: 10% to 100% (in increments of 10%).</p> <p>Use the + and - softkeys to make a change.</p> <p>Changes must be acknowledged with SET (a small icon is displayed after a change has been made, see Figure 31).</p>
	Function
Figure 30/12	<p>Softkey for changing/entering the counter rudder parameter (see also section 1.3.3). Value range: 0 to 9 (in increments of 1) .</p> <p>Use the + and - softkeys to make a change.</p> <p>Changes must be acknowledged with SET (a small icon is displayed after a change has been made, see Figure 31).</p>
Figure 30/13	<p>Softkey for changing/entering the rudder parameter (see also section 1.3.2). Value range: 1 to 9 (in increments of 1).</p> <p>Use the + and - softkeys to make a change.</p> <p>Changes must be acknowledged with SET (a small icon is displayed after a change has been made, see Figure 31).</p>
Figure 30/14	<p>Softkey for changing/entering the yawing parameter (see also section 1.3.1). Value range: 1 to 6 (in increments of 1).</p> <p>Use the + and - softkeys to make a change.</p> <p>Changes must be acknowledged with SET (a small icon is displayed after a change has been made, see Figure 31).</p>
Figure 30/15	<p>Heading (waypoint) change mark; designates the point on the course line (track) when a heading change is commanded or a new waypoint is piloted.</p>
Figure 30/16	<p>Display with graphic information on Track and Distance to course-line (track).</p> <p>The distance between 2 dotted horizontal lines marks the time difference of one minute.</p>

2.3.5.3 NP 5000 Actual Rudder display



Please note:
The NP 5000 Actual Rudder” display indicates the actual rudder angle used for the steering gear control system and may be used as back- up only for the Rudder Angle Indicator required by SOLAS V 19 as amended.

This display shows the following numerical and graphical information:

- Actual heading
- Set heading or Set COG or Track Course
(depends on selected control mode)
- Rudder angle numerical and graphical
- Current operating mode at the Autopilot which is still active.

Figure 33: Display for NP 5000 Actual Rudder with one and 2 rudders

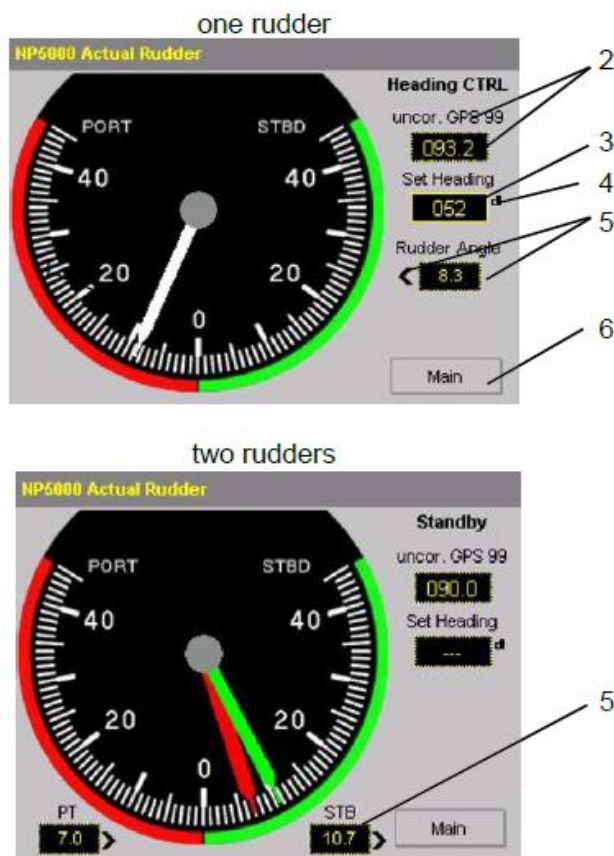

Table 8 Softkeys for NP 5000 Actual Rudder Display

	Function
Figure 32/1	Display with graphic information on the actual rudder angle
Figure 32/2	Information on heading source and actual heading value.
Figure 32/3	Set heading value. For Course Control this display is designated as Presel.COG (Preselected Course Over Ground) after turning the rotary knob, Set COG after releasing the knob (in increments of 1 degree or 1/10 degree - depends on selected resolution). For Track Control this display is designated as Track Course. For Heading Control this display is designated as Set Heading.
Figure 32/4	Touch- icon, toggles resolution for the respective value.
Figure 32/5	Numerical display for the ruder angle in degrees, an arrow next to this display shows the direction of the rudder angle. For <u>2 rudders</u> a second numerical and graphical information is displayed.
Figure 32/6	Softkey for switching to the main display.

2.3.5.4 Acceleration Monitor display (- only for NP 5400 and NP 5500 -)

In the Acceleration Monitor display the current operating mode for the Autopilot is also displayed in the upper right corner below the status bar. In Figure 33 the current mode is standby. Other stated modes are still active.

Figure 34: Displays for Acceleration Monitor

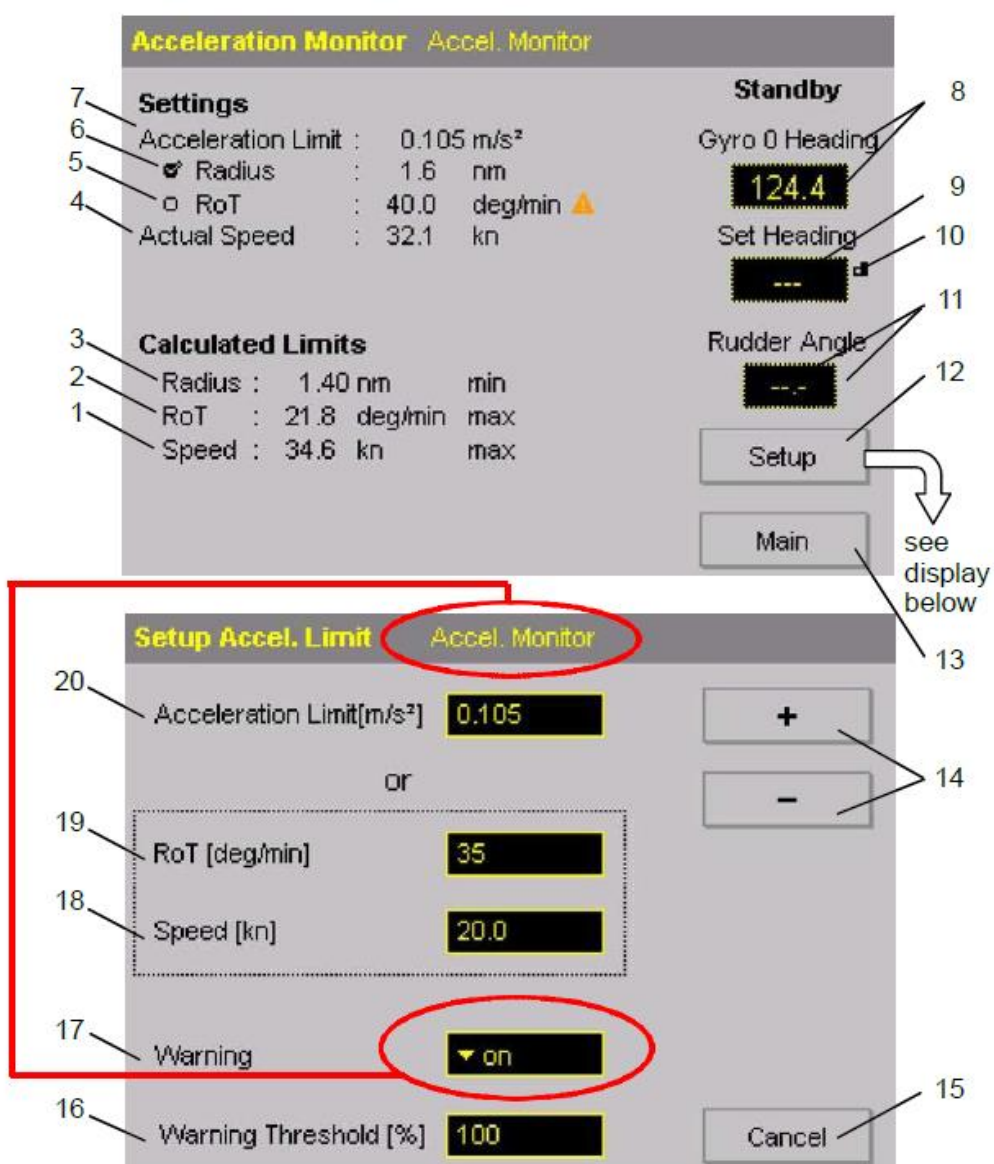

Table 9 Softkeys for Acceleration Monitor Display

	Function
Figure 33/1	Indication of max. speed (as calculated by the settings of acceleration limit, see next display Setup Accel.Limit).
Figure 33/2	Indication of max. RoT (as limited by the settings of acceleration limit, see next display Setup Accel.Limit).
Figure 33/3	Indication of min. Radius (as calculated by the settings of acceleration limit, see next display Setup Accel.Limit).
Figure 33/4	Indication of actual speed.
Figure 33/5	Check box of currently selected RoT- limit adjusted on Main Page. Check box is active if RoT- limit is activated. (see initial display Figure 22).
Figure 33/6	Check box of currently selected RAD- limit (Radius) adjusted on Main Page. Check box is active if RAD- limit is activated. (see initial display Figure 22).
Figure 33/7	Indication of actual acceleration limit.
Figure 33/8	Information on heading source and actual heading value.
Figure 33/9	Set heading value. For Course Control this display is designated as Presel.COG (Preselected Course Over Ground) after turning the rotary knob, Set COG after releasing the knob (in increments of 1 degree or 1/10 degree - depends on selected resolution). For Track Control this display is designated as Track Course. For Heading Control this display is designated as Set Heading.
Figure 33/10	Touch- icon, toggles resolution for the respective value.
Figure 33/11	Numerical display for the ruder angle in degrees, the arrows next to this display show the direction of the rudder angle.
Figure 33/12	Softkey for switching to Setup Accel. Limit display.
Figure 33/13	Softkey for switching to the first display (main page).
Figure 33/14	Softkeys for changing the selected acceleration limit parameters. Changes must be acknowledged with SET (a small icon is displayed after a change has been made see also Figure 34).
Figure 33/15	Softkey for switching back to the previous display, without a transfer of changed values.
Figure 33/16	Softkey for adjusting the threshold (in percent of adjusted acceleration limit). An overshoot of this threshold leads to an acoustic alarm at the Autopilot (only if the softkey Warning is set to on). Value range: 50% to 100%/ (in increments of 5%).

	Function
Figure 33/17	Softkey for switching an alarm ON or OFF if the acceleration overshoots an adjusted acceleration limit value (percentage value). Possible settings are: - Off (no alert) - On (an alert is activated if the limit is reached or exceeded). Accel. Monitor is displayed in the status bar at the top of the display.
Figure 33/18	Softkey for adjusting speed. Adjusted value influences the Acceleration Limit (indication at the top of this display). Value range: 0.0 kn to 90.0 kn (in increments of 1 kn).
Figure 33/19	Softkey for adjusting the Rate of Turn (in degrees) in combination with the speed. Adjusted value influences the Acceleration Limit (indication at the top of this display). Value range: 5 °/min to 500 °/min (in increments of 1 °/min.)
Figure 33/20	Softkey for adjusting the acceleration limit. This adjustment influences the Rate of Turn in the display below. Value range: 0.000 m/s ² to 9.999 m/s ² (in increments of 0.001 m/s ²).

Please note:

Critical values are displayed with a small attention icon. These values must be checked and corrected.

Figure 35: Example of a request to press "SET" after a parameter has been changed

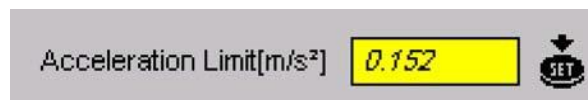

2.3.5.4.1 Application hints for the Acceleration Monitor

The Acceleration Monitor supports the user adjusting RAD/RoT limits in a way for that the acceleration limit will not be met. Additionally, if the calculated limits (speed, RAD/ RoT) are about to reach the acceleration limit, an alert is generated to inform the user. If the set limits do not fit the calculated limits, this will be displayed in the Acceleration Monitor display. If function Warning is active (see Figure 33/17), an additional alert is generated.

Referring to

Figure 33

General:

Positions 4 to 7 are the current values.

Positions 1 to 3 are the current calculated limits for the acceleration monitor.
An excess of such a limit leads to an alert (if this function is enabled see position 17).

Position 20 displays the monitored limit value for alerts.

The cross-acceleration limit value (position 20) can be either adjusted or calculated. The base of this value depends on ships speed and turn radius or rate of turn.

If the maximum tolerable acceleration is known (ask the ship's command), it can be directly adjusted, by input/change (positions 14 and 20).

The values for rate of turn and speed are adapted accordingly.



For information only:

Radius (position 3) is calculated based on Acceleration Limit (position 7) and Actual Speed (position 4).

RoT (position 2) is calculated based on Acceleration Limit (position 7) and Actual Speed (position 4).

Speed (position 1) is calculated based on Acceleration Limit and Radius (position 6) or RoT (position 5).

If this value is unknown, it can be calculated by the NautoPilot® Operator Unit itself. This calculation is performed using rate of turn (position 19) and speed (position 18).

The calculated cross acceleration limit is displayed on the fly (see position 20). Additionally (during the input of the respective value) an alert is indicated in the Acceleration Monitor page if this value could lead to an alert (by a small attention sign behind the respective line).

Radius or rate of turn and speed should be adjusted in that manner, as they will lead (according to experience) to a safety sea trial.

After the values are input (procedure to press SET) and the warning is enabled (see position 17) an alert is triggered on exceeding this acceleration limit and indicated by an acoustical sound and an orange yellowish warning bar.

It is advantageous to input a percentage value (see position 16). This percentage value generates an alert before the maximum tolerable acceleration occurs.

2.3.5.5 Position Monitoring display (- not for NP 5100 -)



Please note (only for Course Control):
It is advisable to check the "Set", "Drift" and "Off Position Limit" settings to prevent needless alarms, which are caused by changing environmental conditions (drift).
The settings should be checked and adapted more often, either after changed environmental conditions (drift) or after course changes.

General information on Position Monitoring

This function compares position information from different source. It compares either the position information of 2 different sensors, or the information from one source with Dead Reckoning position data.

If the difference between the monitored sources exceeds the Off Position Limit, an alert is generated.

Figure 36: Display for the Position Monitoring function (no limit exceeded)

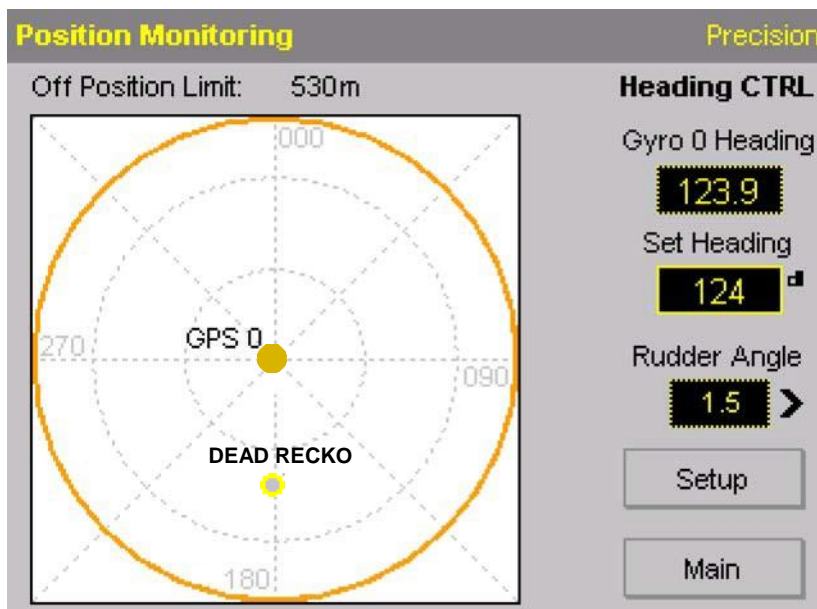

Displayed position sensors can be GPS, Loran C, ECDIS or Dead Reckoning, the corresponding data source is displayed with GPS, LC, II or Dead Recko (Figure 35 shows a dead reckoned position).

In the upper right corner below the status bar the current operating mode of the Autopilot is displayed. This mode is still active.

The unique number of the position sensor depends on the selection of the external navigation data evaluation and distribution system.

The position sensor in use (Autopilot control function) is displayed in the center.

As shown in Figure 35 there is a comparison between GPS0 and a dead reckoned position. The limit of 530 m is not exceeded but there is a difference of approx. 300 m to the south.

Figure 37: Display for the Position Monitoring function (limit exceeded)

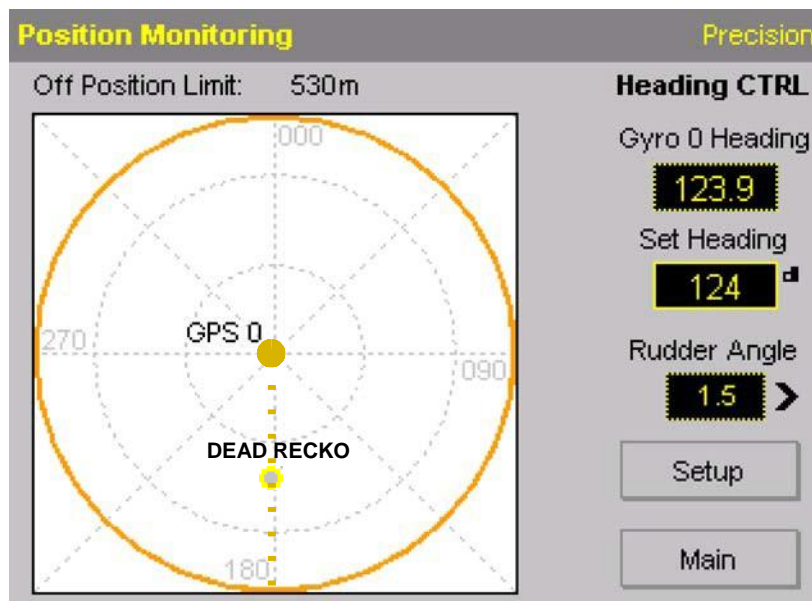

As shown in Figure 36 there is a comparison between GPS0 and a dead reckoned position:

- The limit of 530 m has been exceeded before (dotted line: drift line).
- An alert was activated and acknowledged.
- The dead reckoning position jumps back onto the GPS0 position and adopts the GPS0 value again.
- The limit will be exceeded again.

Figure 38: Display for the Position Monitoring function (limit exceeded and different drift)

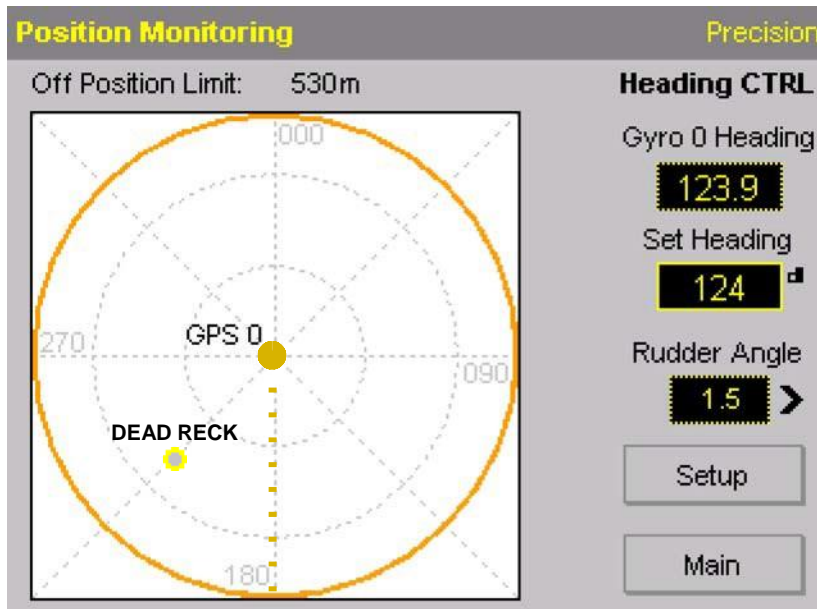

As shown in Figure 37 there is a comparison between GPS0 and a dead reckoned position:

- The limit of 530 m has been exceeded before (dotted line: drift line).
- An alert was activated and acknowledged.
- The last drift direction is displayed (dotted line: drift line). Drift changed.
- The dead reckoning position jumps back onto the GPS0 position and adopts the GPS0 value again.
- The limit will be exceeded again, but in another direction due to different drift. The new drift line will mark this direction.

The process will continue as described for Figure 36.

In order to stop the dead reckoning from drifting away, copy the calculated data to the adjustable data (see Figure 39/9).

Figure 39: Display for the Position Monitoring function (general information)

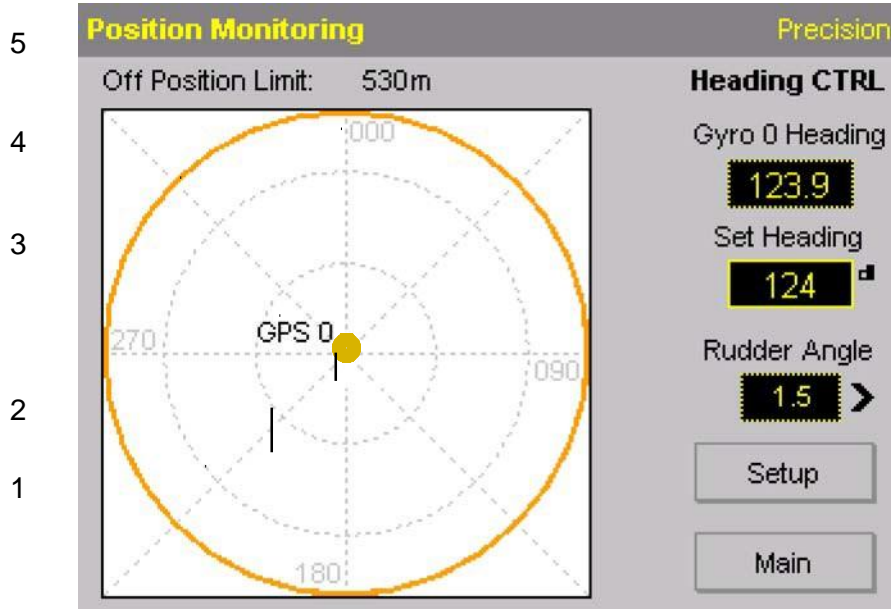

Table 10 Definitions within the Position Monitoring Display

	Function
Figure 38/1	Range rings. These range rings are displayed proportional to the Off Position Limit. The steps displayed are: 1 m- 10 m- 100 m- 1000 m 2 m- 20 m- 200 m- 2000 m 5 m- 50 m- 500 m- 5000 m The example in Figure 38 shows one range ring at a distance of 200 m from the center and a second range ring at a distance of 400 m.
Figure 38/2	The position sensor in use is always displayed in the center.
Figure 38/3	The type and number of the position sensor.
Figure 38/4	The Off Position Limit is displayed in yellow. It is always the maximum of the displayed circle (as shown in Figure 38, it marks 530 m).
Figure 38/5	The direction is always true north (000°).

Figure 40: Displays for Position Monitoring (adjustments)

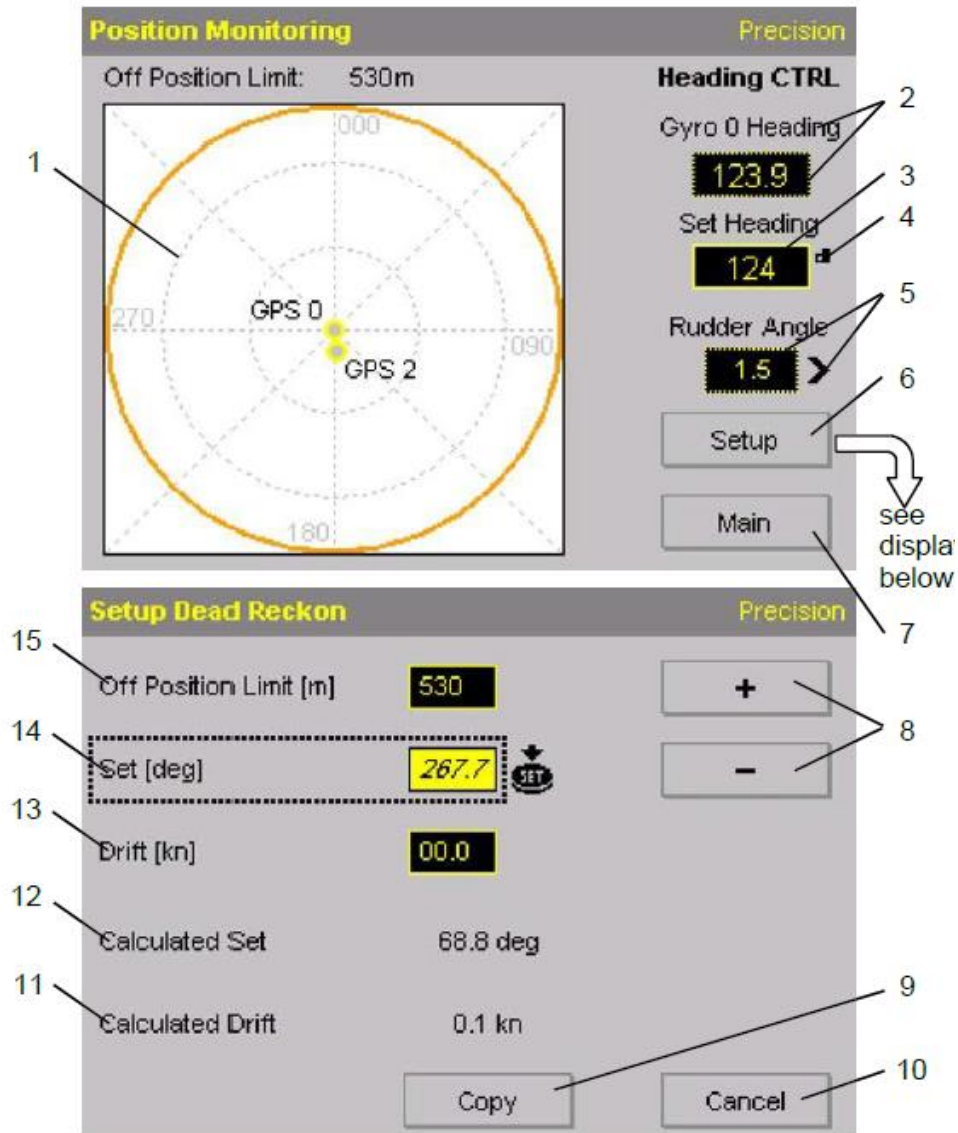

Table 11 Softkeys for Position Monitoring Displays

	Function
Figure 39/1	Display, shows the position of a maximum of 2 GPS receivers and their relative position to the ship. The position sensor in use (control function of the Autopilot) is always in the center.
Figure 39/2	Information on heading source and actual heading value.
Figure 39/3	Set heading value. For Course Control this display is designated as Presel.COG (Preselected Course Over Ground) after turning the rotary knob, Set COG after releasing the knob (in increments of 1 degree or 1/10 degree - depends on selected resolution). For Track Control this display is designated as Track Course. For Heading Control this display is designated as Set Heading.
Figure 39/4	Touch- icon for switching to a higher resolution for the set heading value.
Figure 39/5	Numerical display for the rudder angle in degrees; an arrow next to this display shows the direction of the rudder angle.
Figure 39/6	Softkey for switching to a Setup Dead Reckon display.
Figure 39/7	Softkey for switching to the previous display.
Figure 39/8	Softkeys for changing the selected dead reckoning parameters. Changes must be acknowledged with a SET (a small icon is displayed after a change has been made, see also Figure 40).
Figure 39/9	Softkey for copying the calculated set and drift values for the calculation of a dead reckoning position to the corresponding adjustable set and drift fields. These values must be acknowledged with SET (after copying) to become active.
Figure 39/10	Softkey for switching back to the previous display, without a transfer of changed values.
Figure 39/11	Numerical indication of calculated Drift; the calculation is based on the values from the position sensor in use.
Figure 39/12	Numerical indication of calculated set; the calculation is based on the values from the position sensor in use.
Figure 39/13	Softkey for adjusting an observed drift. This value can be input from the user and influences the position of Dead Reckoning on the display. Value range: 00.0 kn to 99.9 kn (in increments of 0.1 kn).

	Function
Figure 39/14	Softkey for adjusting the observed heading. This value can be input from the user and influences the position of Dead Reckoning on the display. Value range: 000.0° to 359.9° (in increments of 0.1°).
Figure 39/15	Softkey for adjusting the Off Position Limit. This value is the alarm threshold for the monitoring function; it is displayed as the outer circle (yellow). Value range: 0 m to 9999 m (in increments of 1 m).

Figure 41: Example of a request to press SET after a parameter has been changed



2.3.5.6 Ship Data display

Figure 42: Display of Ships data (example)

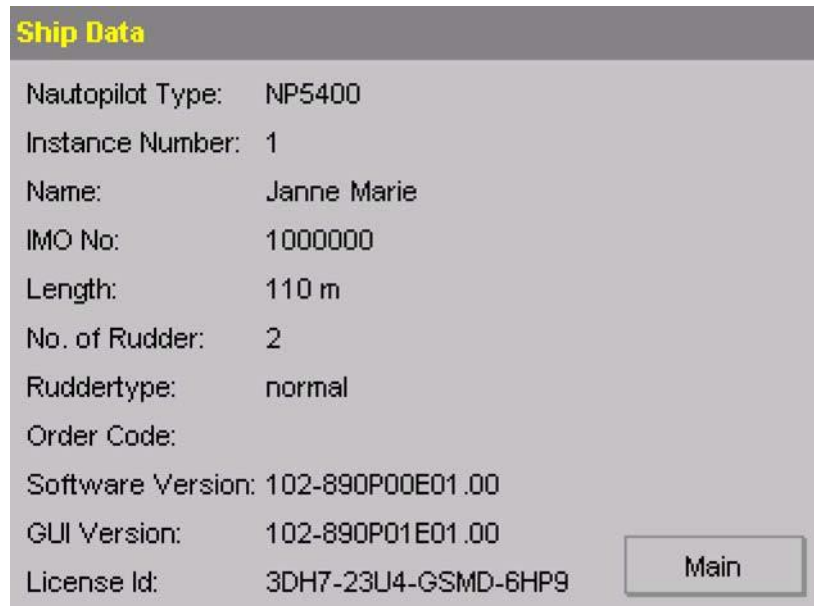
A screenshot of a software interface showing ship data. The title "Ship Data" is in yellow on a dark grey background. Below it, various fields are listed in a light grey area. A "Main" button is visible in the bottom right corner.

Ship Data	
Nautopilot Type:	NP5400
Instance Number:	1
Name:	Janne Marie
IMO No:	1000000
Length:	110 m
No. of Rudder:	2
Ruddertype:	normal
Order Code:	
Software Version:	102-890P00E01.00
GUI Version:	102-890P01E01.00
License Id:	3DH7-23U4-GSMD-6HP9

All the above- mentioned ship's data can be edited in the configuration mode (see Service Manual) except for the Software Version, GUI Version (Graphic User Interface) and License ID.

2.3.6 Page function

Use this function to change current parameters, values, data sources and limits. Depending on which operation the Page softkey is currently performing, one of the following displays will be shown:

- Display with no indication
- Display with softkey to perform changes
- Display with the main current settings

Figure 43: Page function displays

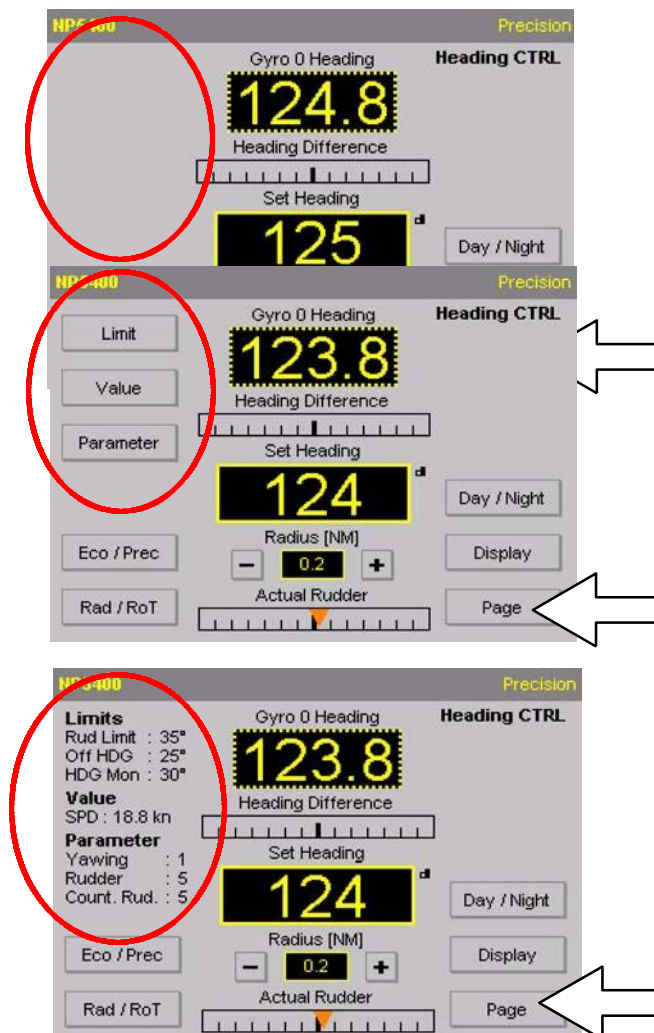

Figure 44: Indicated values/parameters (Page function)

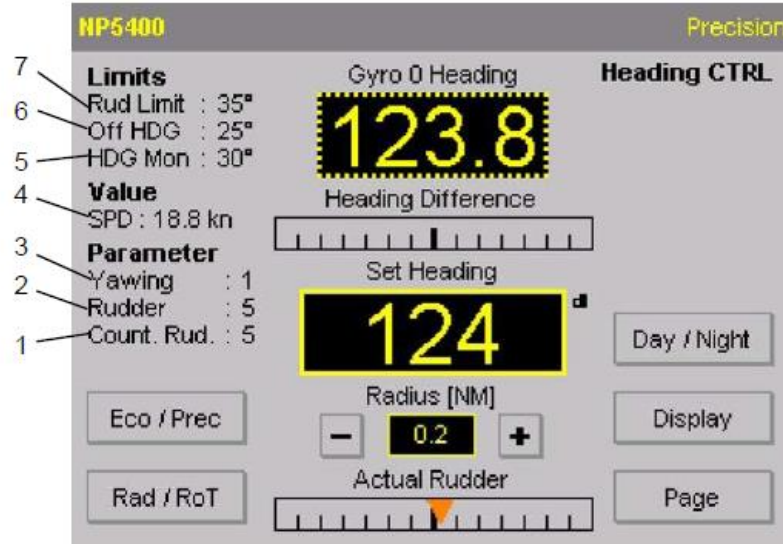
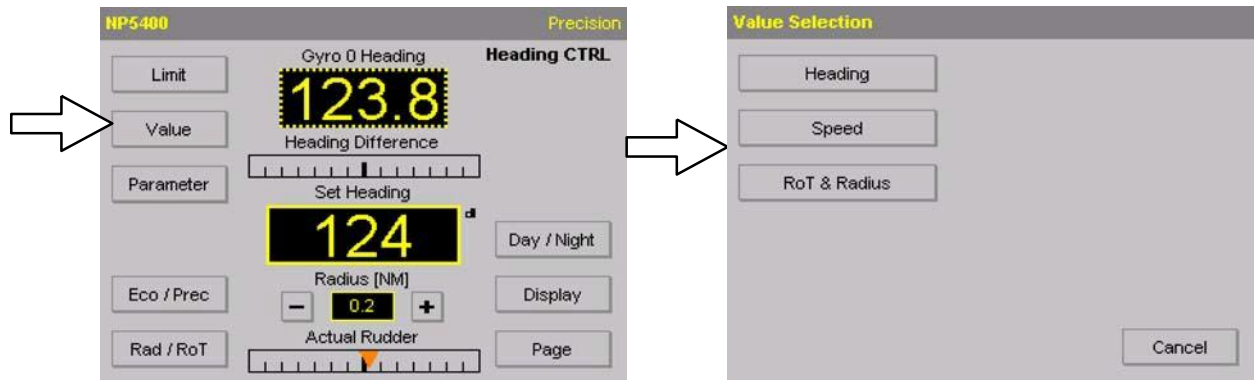

Table 12 Indicated values/parameters (Page function)

	Function
Figure 43/1	Adjusted Counter rudder parameter (see also section 1.3.3). Value range: 1 to 9 (in increments of 1).
Figure 43/2	Adjusted rudder parameter (see also section 1.3.2). Value range: 1 to 9 (in increments of 1).
Figure 43/3	Adjusted yawing parameter (see also section 1.3.1). Value range: 1 to 6 (in increments of 1).
Figure 43/4	Indicates speed value used by the controller. Value range for manual adjustment: 5.0 kn to 90.0 kn, (in increments of 0.1 kn).
Figure 43/5	Heading monitor displays the configured limit for the Heading Monitor alert. Value range: 5° to 30° (in increments of 1°) (see section 1.3.5).
Figure 43/6	Off Heading displays the configured limit for the Off Heading alert. Value range: 5° to 30° (in increments of 1°) (see section 1.3.6).
Figure 43/7	This adjustment is used during the control function of the Autopilot and should be adjusted within the configured limits. (Configuration value = maximum/physical rudder limits, Adjusted value in the Page function = limits for the control loop). Value range: 5° to 35° (in increments of 1°) (depends on configured limits - theoretical 5° to 180°).

Figure 45: Calling- up values for adjustment (Page function)



Use the Value softkey to open another window and select heading, speed or RoT & Radius adjustments.

2.3.6.1 Heading

Figure 46: Heading source selection (Page function)

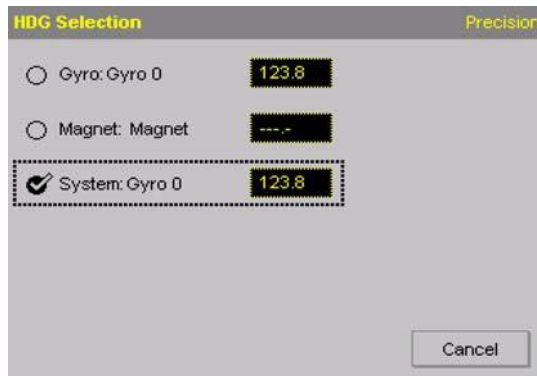

After pressing the Heading softkey the display will appear as shown in Figure 45.

Heading values cannot be changed; the heading source can be selected by activating the appropriate radio button (however one heading source must be selected).

The selected heading source is indicated on the initial display (see Figure 22).

Note: Use of the magnetic compass during Track Control is not permitted, Track Control mode is aborted at once after selection of a magnetic compass. It is not possible to select Track Control mode while magnetic heading is used.

Notes on the heading source selection:

Gyro/GPS

If only one Gyro Compass is connected, this compass acts as the active heading source.

If several Gyro Compasses are connected within a navigation system, the compass with the better performance or with an ascertained sequence is selected for the task.

The performance or sequence is ascertained via an external system for navigation data evaluation and distribution.

GPS Compasses are handled like Gyro Compasses. The selected GPS Compass is displayed:

- Gyro: GPS 2
(if there are more than one GPS Compass)

Magnet

If only one magnetic compass is connected, this compass acts as the active heading source.

If several magnetic compasses are connected within a navigation system, the compass with the better performance or with an ascertained sequence is selected for the task.

The performance or sequence is ascertained via an external system for navigation data evaluation and distribution.

System

If this check box is activated, a compass is selected according to the conditions for the selection of a Gyro Compass and a magnetic compass.

The sequence of selection is: Gyro/GPS Compasses first, then magnetic compass. The sequence is Gyro Compasses first, GPS Compasses second and magnetic compasses third.

INS (or heading sensor is not available)

If the Autopilot is installed in an Integrated Navigation System (INS) the heading information is distributed to the Autopilot via a Consistent Common Reference System (CCRS).

Therefore, the heading source cannot be selected (see Figure 46).

In this case the respective radio button is neither visible nor operable.

If the heading sensor is not installed or defect, the radio button is not displayed.

Figure 47: Heading source selection ("Page" function) - heading source not available or INS



Heading sensor not available



INS

Failure or doubtful data

The following figures illustrate some screens at failure or doubtful data:

Figure 48: Heading sensor failed

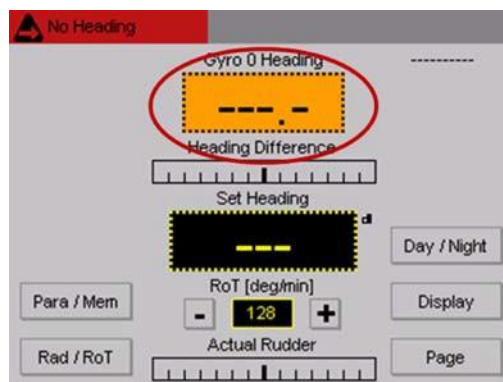

For failure of the heading sensor the heading display turns into yellowish orange color and dashes are displayed instead of a value. Also, the status bar at the upper edge displays the failure stating No Heading (Figure 48).

Figure 49: Speed sensor and Heading sensor doubtful

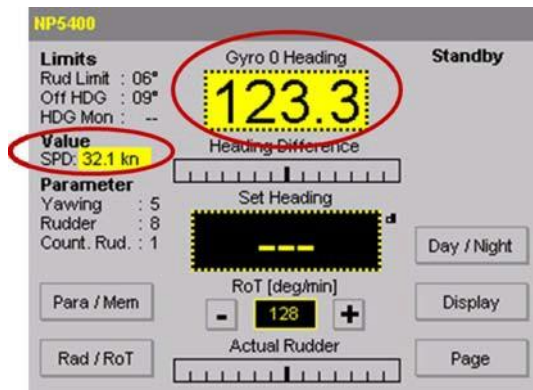

For doubtful values of speed and heading sensor, the background turns into yellow color (Figure 49).

Figure 50: Speed sensor and Heading sensor failed

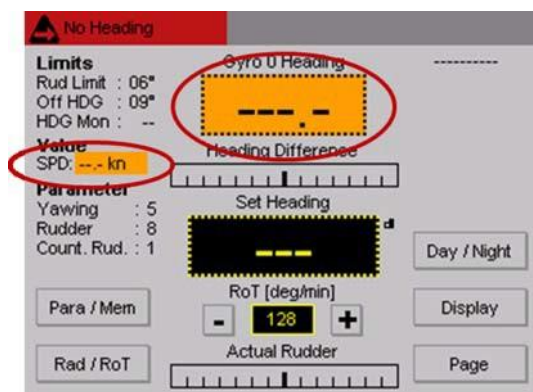

In case of failure of both speed and heading sensor, both areas turn into yellowish orange color and the display shows dashes instead of values. Also, the status bar at the upper edge displays the failure stating No Heading (Figure 50).

2.3.6.2 Speed

Figure 51: Speed source and speed value (Page function)

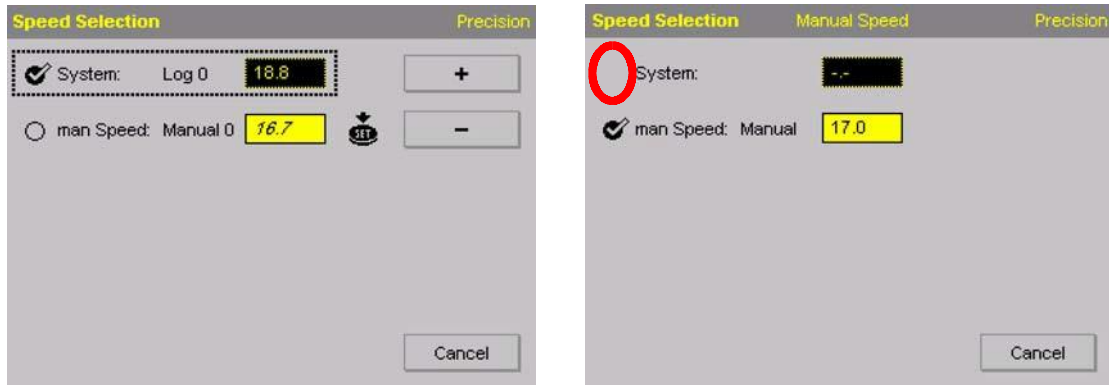

Speed sensor not available.

System

In normal operation the system shows the Speed Through Water (STW)

In data failure of STW the system shows (if a second speed sensor is connected) the Speed Over Ground (SOG).

The speed value of the selected speed sensor cannot be adjusted.

Man Speed

A small icon is displayed, which reminds the operator of acknowledging the input by pressing the SET button, located on the Autopilot's front plate.

Value range: 5.0 kn to 90.0 kn (in increments of 0.1 kn).

If manual speed is selected, it is shown in the display (see Figure 50). This value can be edited without selecting the man Speed option.



Attention:

Only for Track Control mode.

It is important to check the speed value of the connected ECDIS and the speed value adjusted for the Autopilot (independent of manual setting or system setting).

They should not be different.

For integration in an INS the radio button to select speed is neither visible nor operable. See also information about heading source selection (see Figure 46).

For messages regarding failure or doubtful data, refer to chapter 2.3.6.1.

2.3.6.3 RoT & Radius

Figure 52: RoT & Radius (Page function)

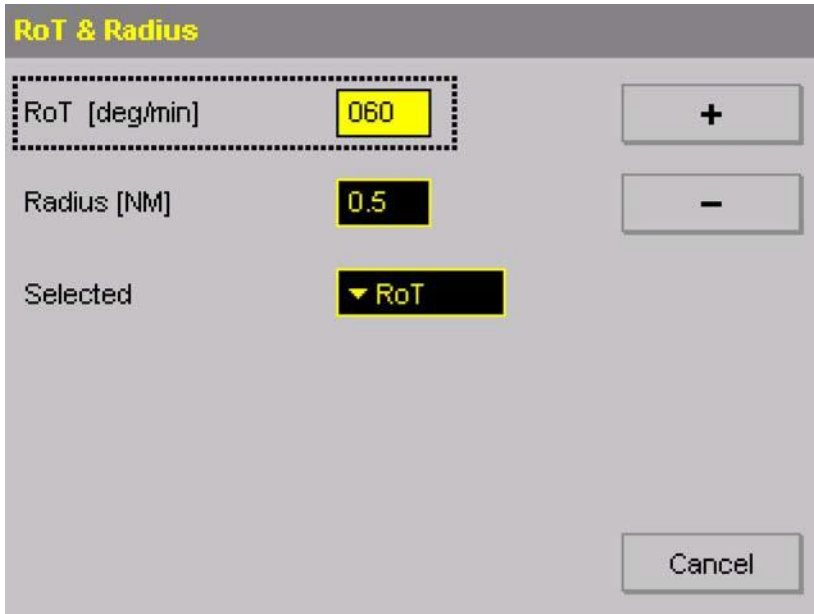

The screenshot shows a configuration window titled "RoT & Radius". It features three main input fields, each with a yellow display and a corresponding softkey:

- RoT [deg/min]:** The display shows "060". To its right is a softkey with a "+" sign.
- Radius [NM]:** The display shows "0.5". To its right is a softkey with a "-" sign.
- Selected:** A pull-down menu showing "▼ RoT".

A "Cancel" button is located at the bottom right of the window.

RoT

Use the + and - softkeys to adjust the max. turn rate for a heading/course change. Press the SET button to transmit this value to the controller.

Value range: 5°/min to 500°/min (in increments of 1°/min).

Radius

Use the + and - softkeys to adjust the min. radius for a heading/course change.

Press the SET button to transmit this value to the controller.

Value range: 0.1 NM to 5.0 NM (in increments of 0.1 NM). (NM = Nautical mile)

Selected

Use this pull-down menu to select a heading/course change mode.

This function is identical to the Rad/RoT softkey; see the first display of Figure 22.

Note: Rad/Rot is not adjustable in mode Track Control with RAYTHEON Anschütz ECDIS

2.3.6.4 Toe Angle

The steering characteristics and energy efficiency on some vessels with 2 rudders or pod-drives can be optimized if the individual rudders are controlled with an offset (toe angle) to each other. A toe angle sets the rudder inwards or outwards with a constant value. The optimum toe angle depends on the speed.

Use this parameter to define the neutral angle of the rudders on a ship with 2 rudders. The neutral angle corresponds to a rudder order of zero degrees.

If the checkbox for toe angle is activated in the main configuration, the parameter Toe Angle [deg] can be adjusted in the RoT & Radius menu.

Adjust the value to set the toe angle:

- Positive value: rudders are turned outwards
- Negative value: rudders are turned inwards

Figure 53: Toe Angle

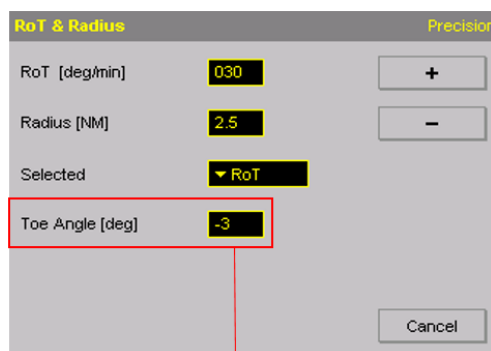

If the value is negative, the rudders adjust as follows:



If the value is positive, the rudders adjust as follows:



Note: In Heading Control, the rudder limit is adhered to. For Track Control, the conditions for the rudder limit apply.

Note: This option must first be configured by Service.

2.3.6.5 Limit values

Figure 54: Limit values (Page function)

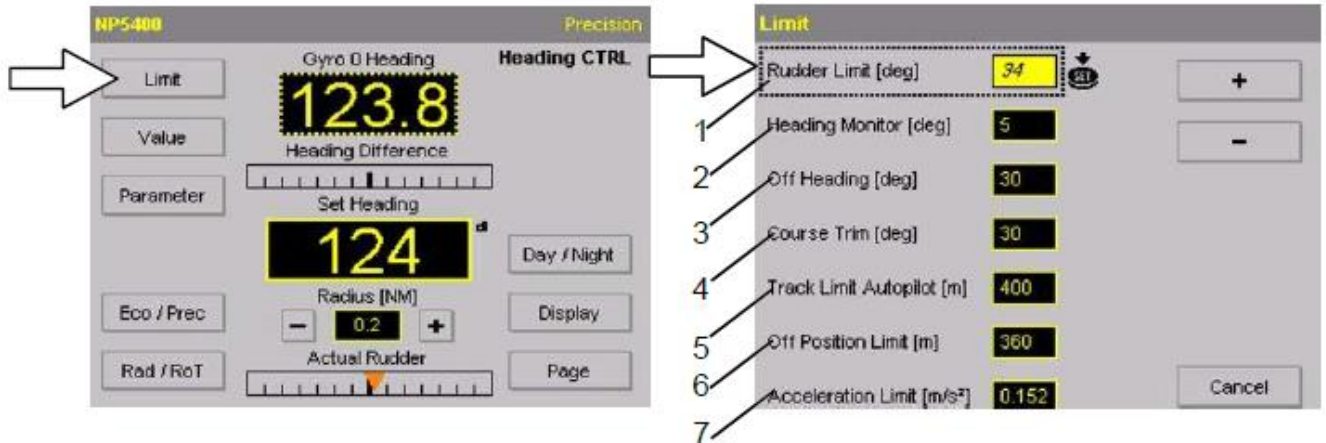

Table 13 Meanings of Limit Values (Page function)

	Function
Figure 53/1	This adjustment is used during the control function of the Autopilot and should be adjusted within the configured limits. It sets limits for command rudder output of the Autopilot. (Configuration value = maximum/physical rudder limits Adjusted value in the Page function = limits for the control loop). Value range: 5° to Max. Rudder Angle, (in increments of 1°, depends on configuration). Refer to Installation Manual, chapter on Max. Rudder Angle.
Figure 53/2	Heading monitor activates an alert if the difference between the Gyro heading and the Magnet heading exceeds this value (see section 1.3.5). Value range: 5° to 30°, (in increments of 1°). A line will be displayed if function is not active.
Figure 53/3	Off Heading; activates an alert if the difference between set heading and actual heading exceeds this value (see section 1.3.6). Value range: 5° to 30°, (in increments of 1°).
Figure 53/4	Course Trim; this value activates an alert if the adjusted angle exceeds the actual heading. This value defines the permitted angle between the actual course and the actual heading (see also section 1.3.7). Value range: 5° to 30°, (in increments of 1°). Activated in Course Control and Track Control modes only.

	Function
Figure 53/5	Track Limit Autopilot; this value activates an alert if the adjusted value exceeds a track limit (stb or pt) - active in Course Control mode only. Value range: 10 m to 2000 m, (in increments of 1 m).
Figure 53/6	OFF Position Limit; this value generates an alarm if the OFF position (according to section 2.3.5.5) is exceeded. Value range: 0 m to 9999 m, (in increments of 1 m) (if configured).
Figure 53/7	Only for NP 5400 and NP 5500. Adjustment of the acceleration limit (see also section 2.3.5.4.1). Value range: 0.000 to 9.999 m/s ² , increment of 0.001 m/s ²

2.3.6.6 Parameter settings

Figure 55: Parameter setting (Page function)

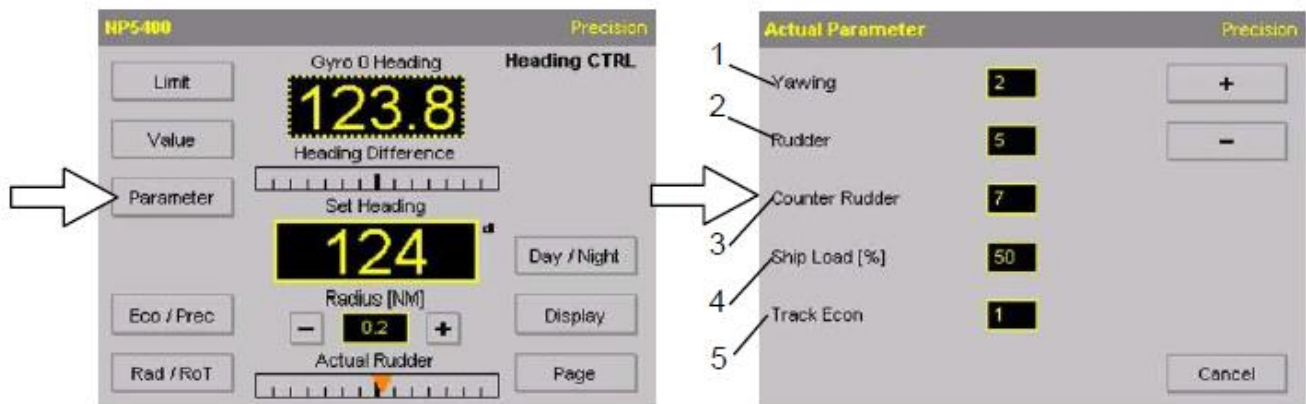

Changes of these parameters will be adopted to the current mode (Heading Control, Course Control or Track Control). Using the NP5500 changes will only be adopted to mode Heading Control mode.

Table 14 Meanings of parameter Settings (Page function)

	Function
Figure 54/1	Softkey for changing/entering the yawing parameter (see also section 1.3.1). Value range: 1 to 6 (in increments of 1). Use the + and - softkeys to make a change. Changes must be acknowledged with SET (a small icon is displayed after a change has been made, see Figure 55).
Figure 54/2	Softkey for changing/entering the rudder parameter (see also section 1.3.2). Value range: 1 to 9 (in increments of 1). Use the + and - softkeys to make a change. Changes must be acknowledged with SET (a small icon is displayed after a change has been made, see Figure 55).
Figure 54/3	Softkey for changing/entering the counter rudder parameter (see also section 1.3.3). Value range: 0 to 9 (in increments of 1). Use the + and - softkeys to make a change. Changes must be acknowledged with SET (a small icon is displayed after a change has been made, see Figure 55).
Figure 54/4	In adaptive mode only. Softkey for changing/entering the ship load condition parameter (see also section 1.3.4). Value range: 10% to 100% (in increments of 10%). Use the + and - softkeys to make a change. Changes must be acknowledged with SET (a small icon is displayed after a change has been made, see Figure 55).
Figure 54/5	Softkey for changing/entering the Track Econ parameter to influence rudder activity (see section 1.3.8).

Figure 56: Example of a request to press SET after a parameter has been changed



2.3.7 Test of NautoPilot® Operator Unit

Note:

This test is not used to test the Autopilot control functions.

This test serves for testing the function of the display, the LEDs, the rotary knob and the buttons.

This test should be activated from time to time or in the case of an assumed malfunction of an operation feature such as the display, the LEDs, the rotary knob or a button.

The test can only be started in a non-automatic mode, i.e. Manual, Standby or Over-ride only.

Start the test by pressing the SET and Illumination buttons simultaneously for approx. 5 seconds.

The display lights up in red, green, blue and black for approx. 15 seconds. Parallel to this the LEDs for Heading, Course and Track light up green and yellow and the LED for alarm and SET request light up yellow.

During this test it is possible to check that the LEDs are lit and that the display shows no blank/dark dots.

The following tests request several different operator actions to test the function of the rotary knob, the buttons at the front plate and some softkey functions on the display. Each single test task is displayed as a request to the operator.

Operator actions must be performed within a set time window - this is shown with a countdown bar.

The test is finished:

- Pressing the SET button at any time or
- double click (double touch) on the touch screen at any time or
- or if the time window exceeds its limit.

The test is aborted/finished and the previous display is shown again.

If defect dots on the Autopilot display result in lack of or wrong information, the replacement of the NautoPilot® Operator Unit is recommended.

Single dot failures do not legitimate for warranty claims. See Pixel Defect Policy, Service Manual.

2.3.8 Quick Tune

It is possible to store up to 5 parameter sets with preset parameters for yawing, rudder and counter rudder.

The application of parameter sets is only possible when the selected mode is non- adaptive (see Figure 56). The check box for adaptive mode is not active. For selection see Service Manual for the NautoPilot® Operator Unit.

Figure 57: Selection of adaptive and non-adaptive mode

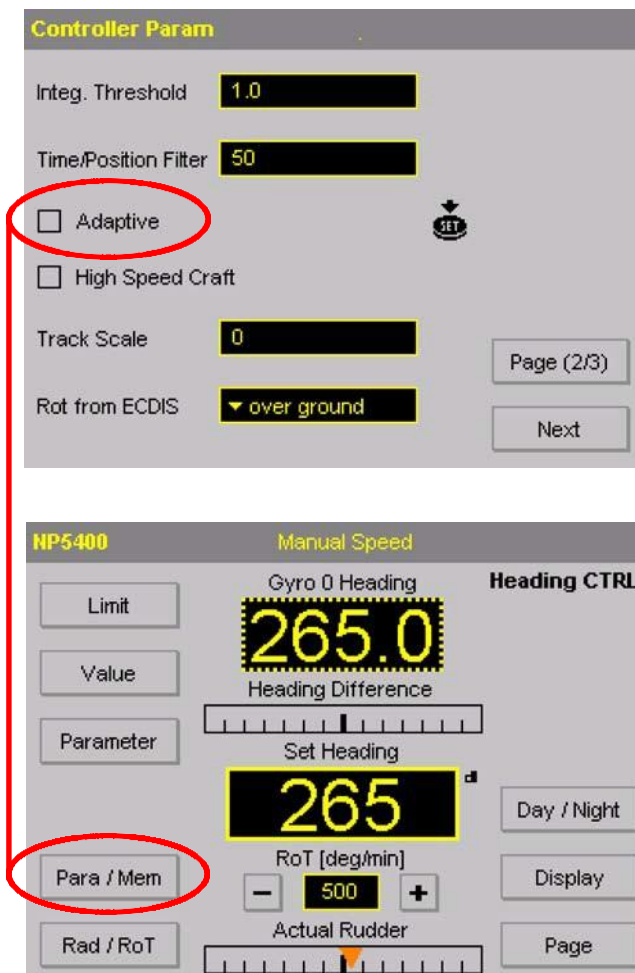

When the non- adaptive mode is selected, the initial display shows a Para/Mem softkey instead of Eco/Prec.

2.3.8.1 Calling up parameter sets

Figure 58: Displays for parameter sets

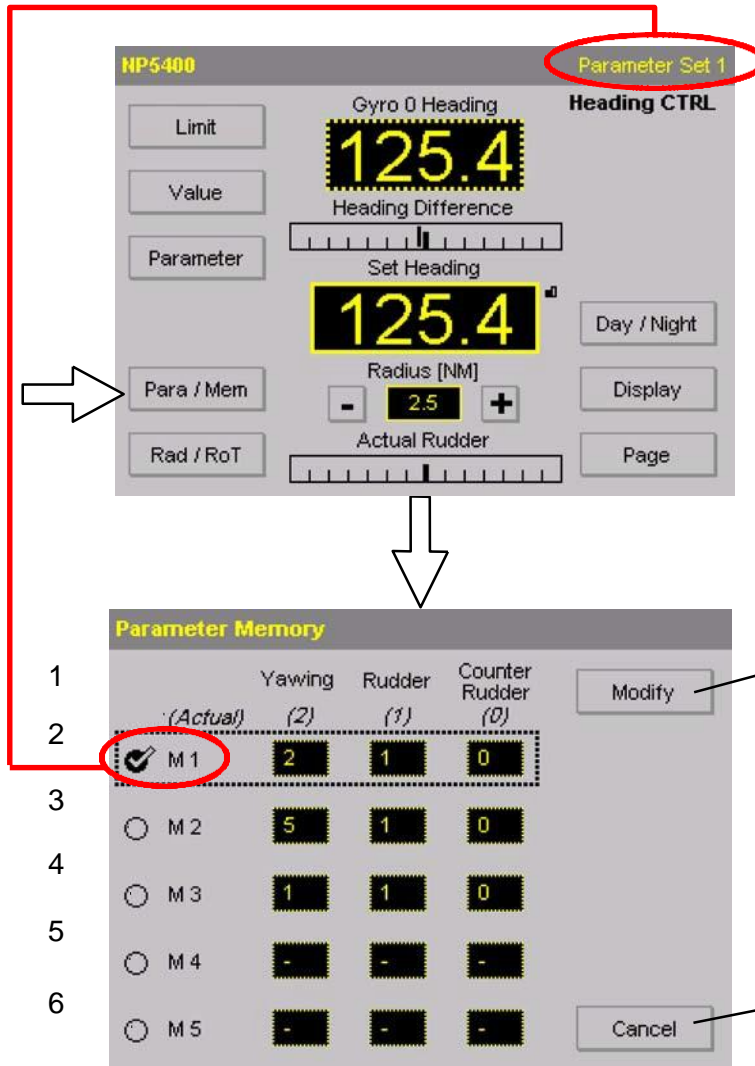

Table 15 Meanings of Parameter Memory

	Function
Figure 57/1	Actual values of the parameters yawing, rudder and counter rudder. These values must not be identical to one of the below parameters sets. A selected parameter set (parameter set M1 is selected as shown) can be changed with the Parameter softkey at the initial display - this changed parameter values are displayed as Actual.
Figure 57/2	Parameter set M1, this parameter set is selected via the check box. If a parameter set is selected, Parameter Set x will be displayed in the upper right corner of the display.
Figure 57/3 to Figure 57/6	Parameter sets M2 to M5 (not selected - only <u>one</u> parameter set can be selected).
Figure 57/7	Softkey for switching back to the previous display without a modification/change of a parameter set.
Figure 57/8	Softkey for modifying the selected parameter set (not for activating this parameter set).

To change a parameter set, press the appropriate softkey for the parameter set you wish to change.

A small icon appears prompting the operator to press the SET button for a parameter set change.

2.3.8.2 Modification of a parameter set

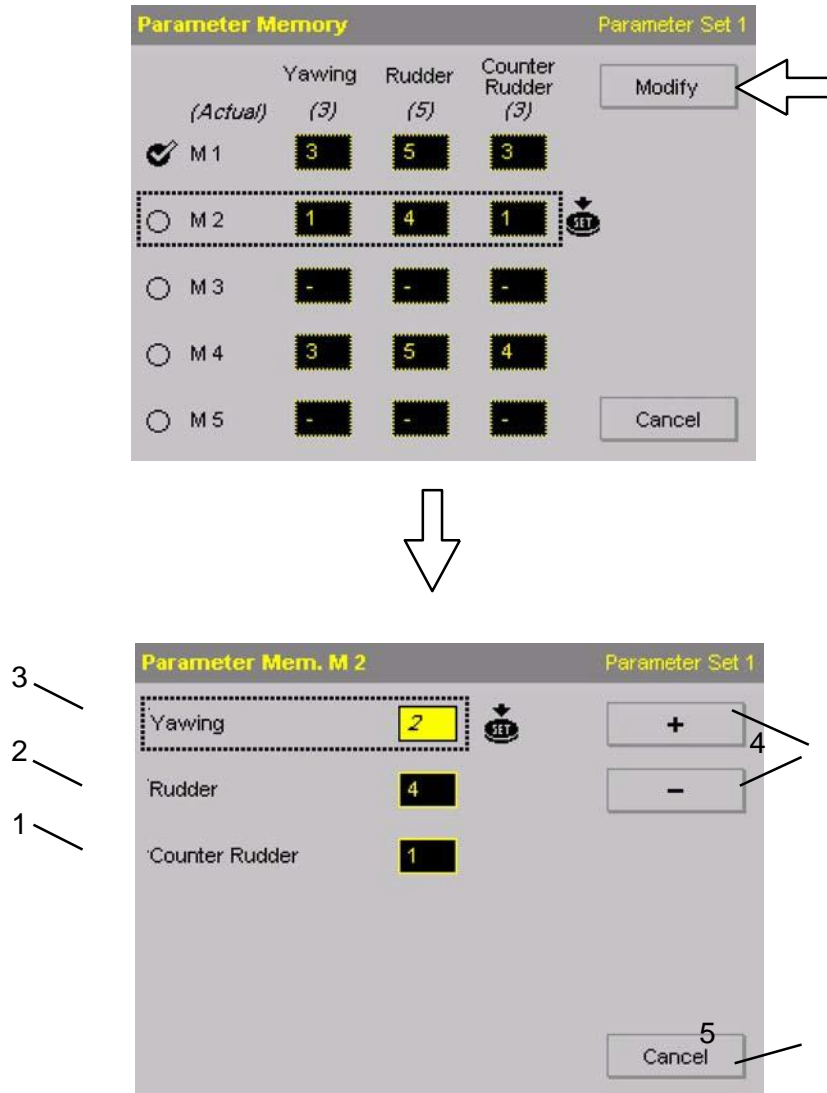

Figure 59: Modification of a parameter set

Please note:

A modified parameter value will not be automatically transmitted to the controller; it is stored only.

After the modification, the modified parameter set must be transmitted to the controller by pressing the SET button.

Table 16 Meanings of parameters for Parameter sets

	Function
Figure 58/1	Softkey for changing/entering the counter rudder parameter (see also section 1.3.3). Value range: 0 to 9 (in increments of 1). Use the + and - softkeys to make a change. Changes must be acknowledged with SET.
Figure 58/2	Softkey for changing/entering the rudder parameter (see also section 1.3.2). Value range: 1 to 9) (in increments of 1). Use the + and - softkeys to make a change. Changes must be acknowledged with SET.
Figure 58/3	Softkey for changing/entering the yawing parameter (see also section 1.3.1). Value range: 1 to 6 (in increments of 1). Use the + and - softkeys to make a change. Changes must be acknowledged with SET.
Figure 58/4	Softkeys for changing the selected parameter. Changes must be acknowledged with SET.
Figure 58/5	Softkey for switching back to the previous display, without a transfer of changed values.

2.4 Switching ON/OFF

After switching on the supply voltage (24 V DC) at a main switch board the NautoPilot® Operator Unit is switched on - there is no separate ON/OFF switch.

For switching OFF, the supply voltage at a main switch board must be switched OFF.

Intentionally left blank

3 Summary of possible adjustments, parameter settings and configurations

The table below is a summary of all adjustable settings arranged in alphabetical order, together with a reference to the section in the Operator Manual in which the setting is explained.

Table 17 Summary of possible Adjustments, Parameter Settings and Configurations

Parameter	Meaning	see section
Acceleration Limit	Influence of RoT and speed. Threshold for acceleration monitor.	2.3.5.4.1
Acceleration Monitor	Influence of RoT and speed.	2.3.5.4
Counter Rudder	Controller Parameter that influences controller performance.	1.3.3, 2.3.5.1, 2.3.5.2, 2.3.6.5
Course Trim	Alert activation caused by the difference between set course or track course and actual heading.	2.3.6.4, Figure
Drift [kn]	Drift for Dead Reckoning.	2.3.5.5
Eco/Prec	Softkey, selection between Economy mode and Precision mode	2.3
Heading	Heading source.	2.3.6.1
Heading Monitor	Alert activation caused by the difference between gyro compass and magnet compass	2.3.6.4
man. Speed	Manual speed input.	2.3.6.2
Off Heading	Alert activation caused by the difference between set and actual heading.	2.3.6.4
Off Position Limit	Alert activation if Off Position Limit for GPS monitoring exceeds the adjusted limit.	2.3.6.4
Para / Mem	Calling up and adjusting of parameter sets (for non- adaptive mode only)	2.3.8
Rad/RoT	Softkey for selecting heading change under RoT control or radius control	2.3
RoT	RoT for acceleration limit	2.3.5.4
Rudder	Controller Parameter that influences controller performance.	1.3.2, 2.3.5.1, 2.3.5.2, 2.3.6.5
Rudder Limit	Rudder limit for the controller function (no physical limits).	2.3.6.4

Set [deg]	Direction of the drift for dead reckoning in Position Monitoring.	2.3.5.5
Ship Load	Typical ship behavior depending on the load	1.3.4, 2.3.5.1, 2.3.5.2, 2.3.6.5
Speed	Speed for acceleration limit	2.3.5.4
Track Limit Autopilot	Autopilot alarm activation if the adjusted track limit is exceeded. (Page function)	2.3.6.4
Warning	Activation / deactivation of warning function for the acceleration monitor.	2.3.5.4
Warning Threshold	Threshold in percent of acceleration limit	2.3.5.4
Yawing	Controller parameter that influences controller performance.	1.3.1, 2.3.5.1, 2.3.5.2, 2.3.6.5

4 Modes of operation, recommended adjustments/settings, examples

4.1 Explanation of symbols used at the Autopilot



Key activation

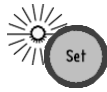

LED *flashing*



LED *off*



LED *on*



Audible signal *on*



Audible signal *off*



Rotary knob pressed/released



Rotary knob turned and pressed



Rotary knob turned

4.2 General notes and recommendations

- Before using the Autopilot, the NautoPilot® Operator Unit and the Autopilot Interface (if installed) must be configured. Adjustment, configuration and operation are strongly influenced by the steering system and its application/performance. Therefore, it is absolutely obligatory that configuration, adjustments and operation must be performed by well- trained, experienced personnel only.
- Use of the magnetic compass as a heading source for Course Control mode and Track Control mode is not permitted
- Activated control functions (such as Heading Control, Course Control or Track Control) should be monitored after their activation. All control functions/modes should be monitored from time to time during a sea trail.
- To prevent dangerous situations, check the traffic at sea and the sea area before activating any control function with the Autopilot.
- The Course Control or Track Control modes can be only activated (switched on) from Heading Control mode. It is possible to switch from Heading Control mode to Course Control mode or Track Control mode.
- If an automatic steering control mode is possible, it is indicated with Standby at the Autopilot.
- Upon reception of a valid ZDA-telegram the received time is used to synchronize the internal clock automatically to the received time information. Without a ZDA telegram a received position information is not used.

Standalone application

An activation of an automatic steering control mode is possible if Standby is indicated and leads to a Heading Control mode at the Autopilot by switching the Main Steering Switch into the respective position.

AS application

The Autopilot must be in Manual mode (indicated by Manual at the display), then the NautoSteer System can be activated, for example with the Main Steering Switch in the respective switch position.

The activation of the NautoSteer System is indicated by Standby at the display.

- A set course change (heading change or preselected heading change) is not possible if:
 - An operating mode is selected which does not allow a heading change via the Autopilot.
 - A display is selected which does not display the heading change value, for example during adjustments.
 - In this case the unintentional operation of the rotary knob is signalized with 5 short acoustical sounds.

4.3 Heading Control

After activating the Heading Control mode, the actual heading value is taken as the set heading value and the Autopilot controls this heading.

4.3.1 Precondition for switching from Standby mode to Heading Control mode

- NautoPilot® Operator Unit is switched on.
- Selected NautoPilot® Operator Unit is active (if there is more than one NautoPilot® Operator Unit) in a steering system.
- Autopilot is in Standby mode.

Table 18 Checks to be made before switching from Standby to Heading Control







Check	Comment
Heading source	The desired heading source is shown above the actual heading value. The heading source can be adjusted via the Page function: Softkeys Page→Value→Heading (see also section 2.3.6.1 and Figure 44)
Heading value	The heading value must be valid. - Check actual heading, as this will be the set heading after switching to Heading Control.
Speed source	The desired speed source is shown and can be adjusted via the Page function: Softkeys Page→Value→Speed (see also section 2.3.6.2 and Figure 50)
Speed value	The speed value must be valid. If speed value is invalid, select Manual Speed. (see also section 2.3.6.2 and Figure 50)
Rudder limit	Adjust rudder limit according to sea area and weather conditions. Softkeys Limit → Limit Page (see also section 2.3.6.4)
RAD/RoT	Adjust RAD/RoT values to be less than the ship's maximum values. Softkey Rad / RoT (see also sections 2.3 and 2.3.6.3)
OFF Heading	Adjust OFF Heading threshold according to traffic in sea area; the more traffic, the smaller the threshold. Softkeys Limit → Limit Page (see also section 2.3.6.4)
Heading monitor	Adjust Heading Monitor threshold according to traffic in sea area; the more traffic, the smaller the threshold. Softkeys Limit → Limit Page (see also section 2.3.6.4)
Alarm/Status	The alarm, warning and status bar (top bar of the display) should not be <u>red/yellowish orange</u> in color. The cause of alerts should be resolved. Alerts should be acknowledged.

4.3.2 Procedure to switch from Standby or Override to Heading Control mode

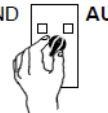
Please note:

- Switching over to an automatic mode should be performed after carrying out the checks according to section 4.3.1.
- After switching over, the actual heading will be taken as the set heading.

Table 19 Procedure to switch from Standby to Heading Control Mode



	Main Steering Switch is in position "Hand".
	Switching off the manual steering mode with a "Main Steering Switch", automatically switches the Autopilot to "Heading Control" mode.
	The "Heading Control" LED (green) shows the activated Heading Control mode. The mode change is displayed at the top right corner of the display (Standby → Heading Control).
or	
	If an override tiller is activated, the Autopilot displays "Override".
	The "Heading Control" LED (green) shows the activated Heading Control mode after release of Override mode. The mode change is displayed at the top right corner of the display (Override → Heading Ctrl).
or	
	For "AS application" devices only. The lower LED is alight (yellow) and "Standby" is indicated. Pressing the button "Heading" activates the Heading Control.
	The "Heading Control" LED (green) shows the activated Heading Control mode. The mode change is displayed at the top right corner of the display (Override → Heading Ctrl).

Please note:

- If there is no automatic switchover to Heading Control (in the event of a wrong or corrupted configuration) it is strongly advised that the operator presses the Heading Control button.
- It is necessary to observe the Autopilot control function after activation.
- For heading changes in Heading Control mode, see section 4.3.6.

4.3.3 Procedure to switch from Course Control mode to Heading Control mode

Table 20 Procedure to switch from Course Control mode to Heading Control Mode



	<p>Course Control mode is active. The mode is displayed at the top right corner of the display (Course Ctrl.).</p>
	<p>Pressing the Heading button activates Heading Control mode. The mode change is displayed at the top right corner of the display (Course Ctrl. → Heading Ctrl.). For heading changes in Heading Control mode, see section 4.3.6.</p>

Please note:



- After switching over, the actual heading from Course Control mode will become the set heading in Heading Control mode.
- It is necessary to observe the Autopilot control function after activation.

4.3.4 Procedure to switch from Track Control mode to Heading Control mode

Table 21 Procedure to switch from Track Control mode to Heading Control Mode

	<p>Track Control mode is active. The mode is displayed at the top right corner of the display (Track Ctrl.).</p>
	<p>Pressing the button Heading activates Heading Control mode (Track Control → Heading Control). The mode is displayed at the top right corner of the display (Heading Ctrl.). For heading changes in the Heading Control mode, see section 4.3.6.</p>

or for non-RAYTHEON Anschütz track planning systems for NP5100 and NP5300 only:

	<p>"Track Control" mode is active. The mode is displayed at the top right corner of the display (Track Ctrl.). All track data are generated and monitored from a connected ECDIS. The Autopilot's task is to control the heading only.</p>
	<p>This mode change must be initialized from a connected ECDIS. For non RAYTHEON Anschütz track planning systems it may be necessary to press the "Heading" button to start "Heading Control" mode. Please check respective operation manual of the non Raytheon Anschütz track planning system. See also section 4.5 (Track Control).</p>
	<p>"Heading Control" mode is active. The mode is displayed at the top right corner of the display (Heading Ctrl.). For heading changes in the Heading Control mode, see section 4.3.6.</p>

Please note:





- It is necessary to observe the Autopilot control function after activation.

4.3.5 Switching off the Heading Control mode

Leaving Heading Control mode is possible only by switching to other control modes or to change the steering mode (manual):

- For switching over to Course Control, see section 4.4.
- For switching over to Track Control, see section 4.5.
- For switching over to Standby, Override or Manual, see instructions below
-

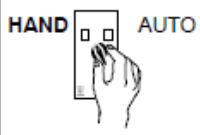





Table 22 Procedure to switch off Heading Control Mode

Standalone application	
 <p>HAND AUTO</p>	Switching the "Main Steering Switch" into position HAND, switches the Autopilot to "Standby".
	The lower LED for standby will light up yellow. The mode change is displayed at the top right corner of the display (Heading Ctrl. → Standby).
or	
 <p>Tiller</p>	Activating a "Tiller" (no NautoSteer Tiller) with an override function switches the Autopilot control mode off. Observe section 1.4.8. Note: With an connected Override Operator Panel the Autopilot can be activated again and starts in "Heading Control" mode at once.
	The lower LED will light up. The mode change is displayed at the top right corner of the display (Heading Ctrl. → Override).

4.3.6 Heading change in Heading Control mode

There are 3 ways to order a heading change (set heading):

Table 23 Procedure for changing heading in Heading Control mode

AS application	
	Switching the "Main Steering Switch" into position HAND, switches the Autopilot to "Manual".
	No LED for activated control modes will light up. The mode change is displayed at the top right corner of the display (Heading Ctrl. → Manual).
or	
 <p>Tiller</p>	Activating a NautoSteer steering device (Tiller AS or Hand-wheel AS) in combination with an Override Operator Unit AS switches the Autopilot control mode off. Observe section 1.4.8. Note: An activation of the Autopilot with the Override Operator Unit AS (button Autopilot), switches the Autopilot into "Heading Control".
	The lower LED for standby will light up yellow. The mode change is displayed at the top right corner of the display (Heading Ctrl. → Override).
or	
 <p>Tiller</p>	Activating a NautoSteer steering device (Tiller AS or Hand-wheel AS) <u>without</u> an Override Operator Unit AS switches the Autopilot control mode off. Observe section 1.4.8.
	The lower LED for standby will light up yellow. The mode change is displayed at the top right corner of the display (Heading Ctrl. → Standby).

- Changing preselected heading value with rotary knob and SET button.
- Changing preselected heading value with turned rotary knob and pressed rotary knob (SET function of the rotary knob).
- Changing the ordered heading directly, by pressing and turning the rotary knob simultaneously.

Preselected heading

Acknowledging the value with the SET button or only with the rotary knob has the same result, but the procedure is different. This procedure can be used, if a heading change is in preparation.





Direct heading

Change the heading directly if a heading change is based on a bearing.



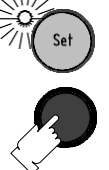

4.3.6.1 Preselected heading change in Heading Control mode

T

Table 24 Procedure for changing preselected heading in Heading Control mode

	<p>Heading Control mode is active. The mode is displayed at the top right corner of the display (Heading Ctrl.).</p>
 <p>Preselected Heading</p> <div style="border: 1px solid black; padding: 2px; display: inline-block;">125.8</div> 	<p>Turning the rotary knob will change the preselected heading value.</p> <p>Please note: After approx. 15 seconds of inactivity from the rotary knob, the primary set heading value will be displayed again.</p> <p>This value is displayed in italic and colors are inverted.</p> <p>The SET LED (near the button) will flash (request to press the SET button).</p>
 <p>Set Heading</p> <div style="border: 1px solid black; padding: 2px; display: inline-block;">125.8</div> 	<p>Pressing the SET button will transmit the preselected value to the controller as the new set heading.</p> <p>The value is now displayed in non- italics and normal colors.</p> <p>The SET LED (near the button) will be off.</p>

or



	<p>Heading Control mode is active. The mode is displayed at the top right corner of the display (Heading Ctrl.).</p>
 <p>Preselected Heading</p> <div style="border: 1px solid black; padding: 2px; display: inline-block;">125.8</div> 	<p>Turning the rotary knob will change the preselected heading value. Please note: After approx. 15 seconds of inactivity from rotary knob, the primary heading value is displayed again. This value is displayed in italic and colors are inverted. The SET LED (near the button) will flash (request to press the SET button).</p>
 <p>Set Heading</p> <div style="border: 1px solid black; padding: 2px; display: inline-block;">125.8</div> 	<p>Pressing the rotary knob transmits the preselected value to the controller as the new set heading (this procedure is similar to that for a Direct heading change). The value is now displayed in non- italics and normal colors. The SET LED (near the button) will be off.</p>

Please note:

- It is necessary to observe the Autopilot control function after a heading change.

4.3.6.2 Direct heading change in Heading Control mode

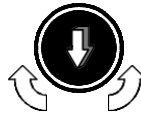
Table 25 Procedure for a direct heading change in Heading Control mode

	<p>Mode Heading Control is active. The mode is displayed at the top right corner of the display (Heading Ctrl.).</p>
 <p>Direct Heading</p> <div style="border: 1px solid black; padding: 2px; display: inline-block;">125.8</div>	<p>Pressing and turning the rotary knob will change the set heading value.</p> <p>This value is displayed in italic and colors are inverted.</p>
 <p>Set Heading</p> <div style="border: 1px solid black; padding: 2px; display: inline-block;">125.8</div>	<p>Releasing the rotary knob will transmit the currently displayed value to the controller as the new set heading.</p> <p>The value is now displayed in non- italics.</p>



Attention.
 The set heading value is changed and the maneuver is executed immediately while pressing and turning the rotary knob.

Please note:

- It is necessary to observe the Autopilot control function after heading change.

4.4 Course Control



- A direct switchover from "Manual" mode to "Course Control" mode is not possible.
- A direct switchover from "Track Control" mode to "Course Control" mode is not possible.
- A direct switchover to "Course Control" is only possible from "Heading Control" mode.
- A direct switchover from "Override" to "Course Control" is not possible.
- "Course Control" mode is not possible without a valid position.
- Activation of "Course Control" mode is not possible with a turn rate of more than 29°/minute during a heading change.



A mode change from "Heading Control" to "Course Control" should not be performed during a heading change in "Heading Control", because of the limited turn rate and the fact, that the actual heading is set as the "set course" at the same time as "Course Control" is activated. It is therefore advisable to finish a heading change in "Heading Control" mode before switching over to "Course Control" mode.

4.4.1 Preconditions for switching to Course Control mode

Table 26 Checks to be made before switching to Course Control mode

Check	Comment
Heading source	The desired heading source is shown above the actual heading value. The heading source can be adjusted via the Page function: Softkeys Page→Value→Heading (see also section 2.3.6.1 and Figure 44). Gyro or GPS must be selected. It is not possible to use magnetic heading.
Heading value	The heading value must be valid. - Check actual heading, as this will be the set Course over Ground after switching to Course Control.

Check	Comment
Speed source	The desired speed source is shown and can be adjusted via the Page function: Softkeys Page→Value→Speed (see also section 2.3.6.2 and Figure 50)
Speed value	The speed value must be valid. If speed value is invalid, select Manual Speed. (see also section 2.3.6.2 and Figure 50)
Position source	If only one position sensor is available, and no speed source is available, it is not possible to activate Course Control (see also section 2.3.5.5).
Position value	The position value must be valid. If no position sensor is available, it is not possible to activate Course Control (see also section 2.3.5.5).
Rudder limit	Adjust rudder limit according to sea area and weather conditions. Softkeys Limit → Limit Page (see also section 2.3.6.4)
RAD/RoT	Adjust RAD/RoT values to be less than the ship's maximum values. Softkey Rad / RoT (see also sections 2.3 and 2.3.6.3)
Course Trim	Adjust Course Trim threshold for deviation from Set Course Over Ground. Softkeys Limit → Limit Page (see also section 1.3.7 and 2.3.6.4)
Heading monitor	Adjust Heading Monitor threshold according to traffic in sea area; the more traffic, the smaller the threshold. Softkeys Limit → Limit Page (see also section 2.3.6.4)
Track Limit	Adjust Track Limit threshold according to traffic in sea area; the more traffic, the smaller the threshold. Softkeys Limit → Limit Page (see also section 2.3.5.2 and 2.3.6.4)
OFF Position Limit	Adjust Limit threshold for deviation between first and second position sensor, e.g. position sensor and dead reckoning. Softkeys Limit → Limit Page (see also section 2.3.5.5 and 2.3.6.4)
Alarm/Status	The alarm, warning and status bar (top bar of the display) should not be <u>red/yellowish orange</u> in color. The cause of alerts should be resolved. Alerts should be acknowledged.

4.4.2 Procedure to switch from Heading Control mode to Course Control mode



	<p>A mode change from "Heading Control" to "Course Control" should not be performed during a heading change in "Heading Control", because of the limited turn rate and the fact that the actual heading is set to "set course" at the same time as "Course Control" is activated. It is therefore advisable to finish a heading change in "Heading Control" mode before switching over to "Course Control" mode.</p>
---	--

Table 27 Procedure to switch from Heading Control mode to Course Control mode

	<p>Heading Control mode is active. The mode is displayed at the top right corner of the display (Heading Ctrl.).</p>
	<p>Pressing the Course button activates the Course Control mode. The mode change is displayed at the top right corner of the display (Heading Ctrl. → Course Ctrl.). For heading changes in the mode Course Control, see section 4.4.5.</p>
<p>Caution! Course Approaching is displayed at the top bar of the display. Rotary knob is disabled and a new set course over ground input is not possible while the heading change maneuver is running. If set course over ground value is reached the caution Course Approaching is no longer displayed. Now it is possible to make a new course change maneuver.</p>	

Please note:

- It is necessary to observe the Autopilot control function after activation.

4.4.3 Procedure to switch from Track Control mode to Course Control mode





It is **not** possible to switch directly from Track Control mode to Course Control mode . It is only possible to switch from Heading Control mode to Course Control mode.

4.4.4 Switching off Course Control mode

It is not possible to switch off Course Control mode - only switching over to other control modes or to a steering mode (manual) is possible:

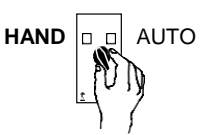

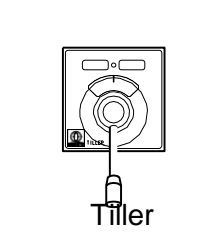



- For switching over to Heading Control, see section 4.3.3.
- For switching over to Standby, Override or Manual see instructions below

Table 28 Procedure to switch off Course Control mode in standalone application

Standalone application	
	Switching the "Main Steering Switch" into position HAND, switches the Autopilot to "Standby".
	The lower LED for standby will light up. The mode change is displayed at the top right corner of the display (Course Ctrl. → Standby). Note: Switching the "Main Steering Switch" into position AUTO, switches the Autopilot to "Heading Control" again.
or	
	Activating a "Tiller" (no NautoSteer Tiller) with an override function, changes the Autopilot mode to "Override". I.e. the Autopilot is not in control of the rudder. Observe section 1.4.8. Note: With a connected Override Operator Panel the Autopilot can be activated again and starts in "Heading Control" mode.
	The lower LED will light up. The mode change is displayed at the top right corner of the display (Course Ctrl. → Override).

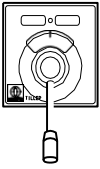
4.4.5 AS application

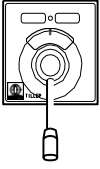
Table 29 Procedure to switch off Course Control mode in AS application

HAND		<p>AUTO</p> <p>Switching the Main Steering Switch into position HAND, switches the Autopilot to Manual</p>
		<p>No LED for activated control modes will light up. The mode change is displayed at the top right corner of the display (Course Ctrl. → Manual).</p> <p>Note: Switching the Main Steering Switch into position AUTO, switches the Autopilot to Heading again.</p>
or		
 <p>Tiller AS</p>		<p>Activating a NautoSteer steering device (Tiller AS or Hand- wheel AS) in combination with an Override Operator Unit AS switches the Autopilot control mode off.</p> <p>Observe section 1.4.8.</p> <p>Note: An activation of the Autopilot with the Override Operator Unit AS (button Autopilot), switches the Autopilot into Heading Control.</p>
		<p>The lower LED for standby (in Heading Control mode) will light up.</p> <p>The mode change is displayed at the top right corner of the display (Course Ctrl. → Override).</p>
or		
 <p>Tiller</p>		<p>Activating a NautoSteer steering device (Tiller AS or Hand- wheel AS) <u>without</u> an Override Operator Unit AS switches the Autopilot control mode off.</p> <p>Observe section 1.4.8.</p>
		<p>The lower LED for standby will light up yellow. The mode change is displayed at the top right corner of the display (Heading Ctrl. → Standby).</p>

For a switching over to Heading Control caused by lost position value, see section 4.4.6.

4.4.6 Course change in Course Control mode



After a course change is indicated in Course Control a new course change can be ordered until the "Course Approach" alert is not indicated. Please note: each time the heading is changed in this way, the "Distance to Course line" is set to zero and must be calculated anew.

There are 2 ways to change a Course Over Ground (COG) value:

- Changing preselected COG value with rotary knob and SET button
- Direct COG change

Preselected

Changing the value with the rotary knob and acknowledging the value with the SET button or with the rotary knob has the same result - but the procedure is a little different.







This procedure can be used, if a COG change is in preparation.

Direct COG change

This procedure is similar to the direct heading change in Heading Control mode, but the new COG value is active after releasing the rotary knob, there is no continuous COG change.



This procedure is displayed also as Preselected COG.

Table 30 Procedure for a course change in Course Control mode

	<p>Course Control mode is active. The mode is displayed at the top right corner of the display (Course Ctrl.).</p>
 <p>Preselected COG</p> <div style="border: 1px solid black; padding: 2px; width: fit-content; margin: 0 auto;">125.8</div> 	<p>Turning the rotary knob will change the set Course Over Ground value.</p> <p>Please note: After approx. 15 seconds of inactivity from rotary knob, the previous Course Over Ground value is displayed again.</p> <p>This value is displayed in italic and bold.</p> <p>The SET LED (near the button) will flash (request to press the SET button).</p>
  <p>Set Course Over Ground</p> <div style="border: 1px solid black; padding: 2px; width: fit-content; margin: 0 auto;">125.8</div> 	<p>Pressing the SET button transmits the preselected value to the controller as the new set Course Over Ground.</p> <p>The value is now displayed in non- italics.</p> <p>The SET LED (near the button) is off.</p>
<p>Caution! Course Approaching is displayed at the top bar of the display. Rotary knob is disabled and a new set course over ground input is not possible while the heading change maneuver is running. If set course over ground value is reached the caution Course Approaching is no longer displayed. Now it is possible to make a new course change maneuver.</p>	

or

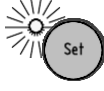
	<p>Course Control mode is active. The mode is displayed at the top right corner of the display (Course Ctrl.).</p>
---	--

 <p>Preselected COG</p> <div style="border: 1px solid black; padding: 5px; text-align: center; width: fit-content; margin: 0 auto;">125.8</div> 	<p>Turning the rotary knob will change the set Course Over Ground value.</p> <p>Please note: After approx. 15 seconds of inactivity from the rotary knob, the previous Course Over Ground value is displayed again.</p> <p>This value is displayed in italic and inverted colors.</p> <p>The SET LED (near the button) is flashing (request to press the SET button).</p>
 <p>Set Course Over Ground</p> <div style="border: 1px solid black; padding: 5px; text-align: center; width: fit-content; margin: 0 auto;">125.8</div> 	<p>Pressing the rotary knob transmits the preselected value to the controller as the new Set Course Over Ground.</p> <p>The value is now displayed in non- italics and normal colors.</p> <p>The SET LED (near the button) is off.</p>
<p>Caution! Course Approaching is displayed at the top bar of the display. Rotary knob is disabled and a new set course over ground input is not possible while the heading change maneuver is running. If set course over ground value is reached the caution Course Approaching is no longer displayed. Now it is possible to make a new course change maneuver.</p>	

Please note:

- It is necessary to observe the Autopilot control function after heading change.

4.4.7 Lost position value in Course Control mode

The Course Control mode is executed for at least 2 minutes and the top bar (yellowish orange) displays Dead Reckoning no Position during this time.

If no valid position is available after 2 minutes, the Course Control mode is stopped and a switchover to Heading Control mode is performed (an appropriate message will be displayed at the top bar).

If a valid position is available, but a position jump is detected, a switchover to Heading Control mode is performed to prevent an unwanted rudder movement.

If a valid position is available without a position jump, the Course Control mode continues, however, all messages (warnings) must be acknowledged.

4.5 Track Control

(see also section 1.4.5)

The Track Control mode can be started from Heading Control mode only. All necessary data for a Track Control are generated from a connected track planning system.

Data for the control function of the Autopilot can be adjusted.

4.5.1 Track Control mode with RAYTHEON Anschütz ECDIS

The Track Control mode is started by a track planning system (ECDIS, Raytheon Anschütz).

	Track Control mode is active. The mode is displayed at the top right corner of the display (Track Ctrl.).
---	--

4.5.2 Preconditions for switching to Track Control mode

Table 31 Checks to be made before switching to Track Control with RAYTHEON Anschutz ECDIS

Check	Comment
Heading source	<p>The desired heading source is shown above the actual heading value.</p> <p>The source is supposed to be the same as displayed at the ECDIS.</p> <p>The heading source can be adjusted via the Page function: Softkeys Page→Value→Heading (see also section 2.3.6.1 and Figure 44).</p> <p>Gyro or GPS must be selected. It is not possible to use magnetic heading.</p>
Heading value	<p>The heading value must be valid.</p> <ul style="list-style-type: none"> - Check actual heading, as this will be the set Course over Ground after switching to Course Control. <p>The value is supposed to be the same as displayed at the ECDIS.</p>
Speed source	<p>The desired speed source is shown and can be adjusted via the Page function: Softkeys Page→Value→Speed (see also section 2.3.6.2 and Figure 50)</p>
Speed value	<p>The speed value must be valid.</p> <p>If speed value is invalid, select Manual Speed. (see also section 2.3.6.2 and Figure 50)</p>
Position source	<p>If only one position sensor is available, and no speed source is available, it is not possible to activate Course Control (see also section 2.3.5.5).</p>
Position value	<p>The position value must be valid.</p> <p>If no position sensor is available, it is not possible to activate Course Control (see also section 2.3.5.5).</p>

Check	Comment
Course Trim	Adjust Course Trim threshold for deviation from Set Track Course Over Ground. Softkeys Limit → Limit Page (see also section 1.3.7 and 2.3.6.4)
Heading monitor	Adjust Heading Monitor threshold according to traffic in sea area; the more traffic, the smaller the threshold. Softkeys Limit → Limit Page (see also section 2.3.6.4)
Track Limit	Adjust Track Limit threshold according to traffic in sea area; the more traffic, the smaller the threshold. Adjust the threshold at the ECDIS (refer to ECDIS manual). At the Autopilot the limit will be displayed only.
OFF Position Limit	Adjust Limit threshold for deviation between first and second position sensor, e.g. position sensor and dead reckoning. Softkeys Limit → Limit Page (see also section 2.3.5.5 and 2.3.6.4)
Requirements for GO- TO- WAYPOINT maneuvers.	Check ship's position and heading in reference to current waypoint. (see section 1.4.5.1, Figure 11 for NP5100 to NP5400 and Figure 12 and Figure 13 for NP5500)
Alarm/Status	The alarm, warning and status bar (top bar of the display) should not be <u>red/yellowish orange</u> in color. The cause of alerts should be resolved. Alerts should be acknowledged.

4.5.3 Waypoint steering mode in combination with GPS, chart plotter or equivalent navigation system

Important Note:

The waypoint steering mode may be used on non- SOLAS vessels only. It must not be used on vessels following SOLAS convention!

IMO has defined 2 different operating modes / systems for automatic steering:

- Heading Control,
- Track Control.

For both of these systems performance and test standards have been defined. Authorities / classification societies test against these standards and issue a corresponding certificate if the products are compliant to these standards.

For waypoint steering mode no performance and test standards have been defined

and thus these systems are not tested by authorities / classification societies.

Please note:

The waypoint steering mode may only be used on non- SOLAS vessels. It must not be used on vessels following SOLAS regulation.

Regulation 3 of SOLAS, Chapter I, Part 1 describes the following exceptions for non- SOLAS vessels:

(a) The present regulations, unless expressly provided otherwise, do not apply to:

- (i) Ships of war and troopships.
- (ii) Cargo ships of less than 500 gross tonnage.
- (iii) Ships not propelled by mechanical means.
- (iv) Wooden ships of primitive build.
- (v) Pleasure yachts not engaged in trade.
- (vi) Fishing vessels.

(b) Except as expressly provided in chapter V, nothing herein shall apply to ships solely navigating the Great Lakes of North America and the River St Lawrence as far east as a straight line drawn from Cap des Rosiers to West Point, Anticosti Island and, on the north side of Anticosti Island, the 63rd meridian.

(SOLAS CONSOLIDATED EDITION 2009, Chapter I,
Regulation 3)

In case of uncertainty please check with your Flag State Authority.

Important Note:

In waypoint steering mode the route - consisting of 2 or more waypoints - is planned on a GPS, chart plotter or equivalent navigation system. NP5000 receives only the data from the navigation system in order to steer the vessel on a certain track. The operator must have good knowledge of the navigation system in use as this system controls the autopilot with regards to heading alterations, track changes and the corresponding alert philosophy.

The operator should closely monitor the progress when sailing on a route. In case of deviations from the route or any uncertainty the operator should switch to heading control.

Activating Waypoint Steering mode

It is possible to activate the waypoint steering mode under the following conditions:

- The NautoPilot® version is NP 5100 or NP 5300 (for NautoPilot® with a higher performance e.g. for type NP 5400 and NP 5500 it is not possible to connect to GPS, chart plotter or equivalent navigation system).
- Heading value is valid and not obtained from a Magnetic Compass.
- Speed value is valid.
- Track Limit Autopilot is configured.
- The serial interface which is connected to the navigational system is configured to NMEA 4800 Bd or NMEA 38400 Bd (see also Installation Manual).
- The navigational system has already transmitted an APB NMEA telegram (according to IEC 61162- 1) (this includes Track Course and a Cross Track error).
- The actual cross track error is not more than 1 nautical mile.
- The difference between the actual heading and the track heading is less than 60°.
- The NautoPilot® is in Heading Control Mode.

After the navigational system has transmitted the APB telegram, the Track button at the NautoPilot® Operator Unit must be pressed to activate waypoint steering mode.



	<p>Waypoint steering mode is inactive. Press Track button.</p>
	<p>Waypoint steering mode is active. The mode is displayed at the top right corner of the display.</p>

Table 32 Checks to be made before switching to waypoint steering using GPS, chart plotter or equivalent navigation systems

Check	Comment
Heading source	The desired heading source is shown above the actual heading value. The source is supposed to be the same as displayed at the ECDIS. The heading source can be adjusted via the Page function: Softkeys Page→Value→Heading (see also section 2.3.6.1 and Figure 44). Gyro or GPS must be selected. It is not possible to use magnetic heading.
Heading value	Heading value is valid and not obtained from a Magnetic Compass.
Speed source	The desired speed source is shown and can be adjusted via the Page function: Softkeys Page→Value→Speed (see also section 2.3.6.2 and Figure 50)
Speed value	The speed value must be valid. If speed value is invalid, select Manual Speed. (see also section 2.3.6.2 and Figure 50)
Position source	If only one position sensor is available, and no speed source is available, it is not possible to activate Course Control (see also section 2.3.5.5).
Position value	The position value must be valid. If no position sensor is available, it is not possible to activate Course Control (see also section 2.3.5.5).
Rudder limit	Adjust rudder limit according to sea area and weather conditions. Recommended to set Rudder limit to Max. in order to achieve best controller performance. Softkeys Limit → Limit Page (see also section 2.3.6.4)
RAD/RoT	Adjust RAD/RoT values to fit setting according to next planned waypoint. RAD/RoT values must be less than ship's maximum values. Softkey Rad / ROT (see also sections 2.3 and 2.3.6.3)
Course Trim	Adjust Course Trim threshold for deviation from Set Course Over Ground. Softkeys Limit → Limit Page (see also section 1.3.7 and 2.3.6.4)
Heading monitor	Adjust Heading Monitor threshold according to traffic in sea area; the more traffic, the smaller the threshold. Softkeys Limit → Limit Page (see also section 2.3.6.4)

Track Limit	Adjust Track Limit threshold according to traffic in sea area; the more traffic, the smaller the threshold. Adjusted Track Limit must be the same as adjusted at the ECDIS. Softkeys Limit → Limit Page (see also section 2.3.5.2 and 2.3.6.4)
OFF Position Limit	Adjust Limit threshold for deviation between first and second position sensor, e.g. position sensor and dead reckoning. Softkeys Limit → Limit Page (see also section 2.3.5.5 and 2.3.6.4)
Alarm/Status	The alarm, warning and status bar (top bar of the display) should not be <u>red/yellowish orange</u> in color. The cause of alerts should be resolved. Alerts should be acknowledged.



4.5.4 Switching off Track Control and Waypoint Steering mode









Track Control and Waypoint Steering can be stopped by activating heading control at the autopilot or by activation of a manual steering control.

Track Control mode can be switched off at RAYTHEON Anschütz ECDIS - the Autopilot is switched to Heading Control mode automatically.

- For switching over to Heading Control, see section 4.3.3.
- For switching over to Standby, Override or Manual, see instruction below

Table 33 Procedure to switch off Track Control mode

Standalone application	
	Switching the "Main Steering Switch" into position HAND, switches the Autopilot to "Standby".
	The lower LED for standby will light up. The mode change is displayed at the top right corner of the display (Track Ctrl. → Standby).
or	

 Tiller	Activating a "Tiller" (no NautoSteer Tiller) with an override function, switches the Autopilot to Override mode. Observe section 1.4.8. Note: The Autopilot can be activated at the connected Override Operator Panel and starts in "Heading Control" mode at once.
 Heading	The lower LED will light up. The mode change is displayed at the top right corner of the display (Track Ctrl. → Override).
AS application	
 HAND AUTO	Switching the "Main Steering Switch" into position HAND, switches the Autopilot to "Manual".
 Track	No LED for activated control mode will light up. The mode change is displayed at the top right corner of the display (Track Ctrl. → Manual).
or	
 Tiller	Activating a NautoSteer steering device (Tiller AS or Hand-wheel AS) with an Override Operator Unit AS, switches the Autopilot to Override mode. Observe section 1.4.8. Note: An activation of the Autopilot with the Override Operator Unit AS (button Autopilot), switches the Autopilot into "Heading Control".
 Heading	The lower LED for standby will light up. The mode change is displayed at the top right corner of the display (Track Ctrl. → Override).
or	
 Tiller	Activating a NautoSteer steering device (Tiller AS or Hand-wheel AS) <u>without</u> an Override Operator Unit AS switches the Autopilot control mode off. Observe section 1.4.8.
 Heading	The lower LED for standby will light up yellow. The mode change is displayed at the top right corner of the display (Heading Ctrl. → Standby).

Faults detected at the ECDIS during Track Control mode will stop this mode. An automatic switchover to Heading Control mode is performed.

On straight leg: The RAD and RoT values and the rudder limit, which were adjusted by the operator, are now used and displayed.

On curved path: On interruption, the rudder limit is set to maximum value and RAD/RoT are taken from the next planned section.

5 Description Additional Autopilot Control Unit (AACU)

With the Additional Autopilot Control Unit, it is possible to control the NautoPilot® in the modes:

- Heading Control
- and Course Control.

In addition, a Curved Heading Line is displayed in the Raytheon SYNOPSIS NX ECDIS and RADAR systems.

5.1 Switching ON / OFF

After switching on the supply voltage (24 V DC) at a main switch board the NautoPilot® Operator Unit and the Additional Autopilot Control Unit is switched on. There is no separate ON/OFF switch.

For switching OFF, the supply voltage at a main switch board must be switched OFF.

5.2 Operation elements of the Additional Autopilot Control Unit

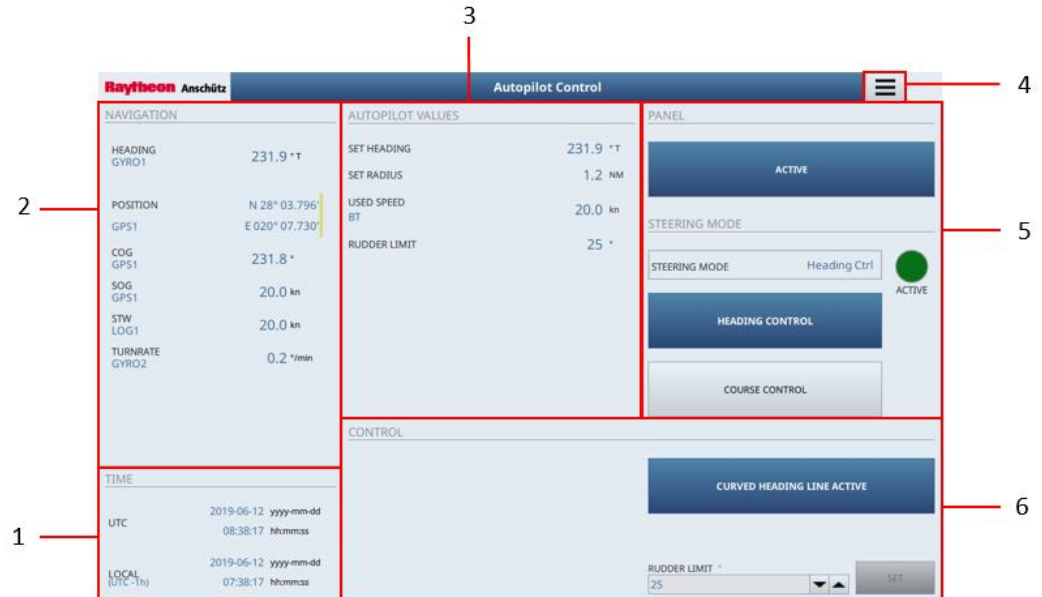

Table 34 Operation elements AACU

No.	Section	Description
1	Date and Time Information	The section Date and Time Information displays the Date, UTC and local time.
2	Navigation	The section NAVIGATION displays the related navigational sensor information.
3	Autopilot Values	The section AUTOPILOT VALUES displays the current values set on the NautoPilot®.
4	Menu	Opens the menu for general settings.
5	Panel	The section PANEL displays the current mode of the panel. In addition, the settings can be changed via touch operation.
6	Control	The section CONTROL activates the Additional Autopilot control and the ruder limit can be adjusted.

5.2.1 Date and Time Information

This section displays the Date and Time Information.

5.2.2 Navigation

This Section displays Navigation Information. Below the designations are the sensors that supply the data. On the right side, a colored quality indicator may appear if the sensor has doubtful integrity or no valid and plausible data.



Example:



Table 35 Example Section Navigation (AACU)

Course over ground (COG)	72.0°
Sensor	GPS1
Colored quality indicator	yellow

Table 36 Description of the Quality Indicators according to IEC 62288

Quality Indicator (IEC 62288)	Description
No indicator	The sensor has good integrity.
Yellow 	The sensor has doubtful integrity. Data from this sensor can be used carefully, but not for automatic control functions. Please Note: If there is only one source for a certain type of data, this source has doubtful integrity. In this case, doubtful integrity is not a marker for an error.
Orange 	No valid and plausible data available from the sensor.

5.2.3 Autopilot Values

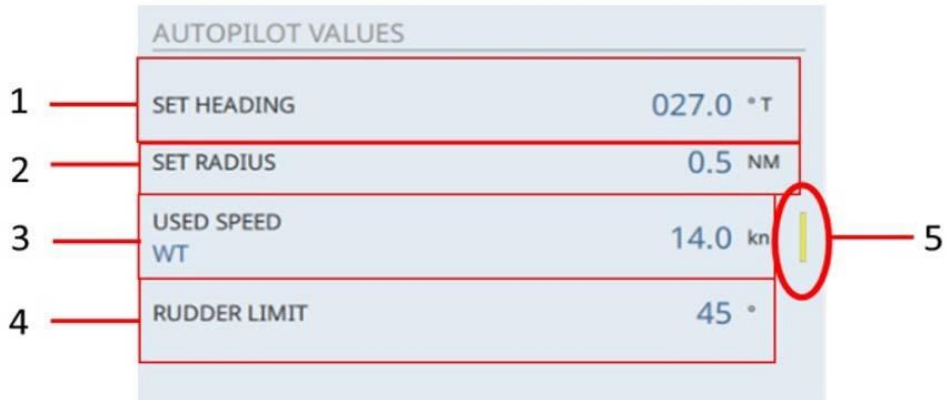

Figure 60: Autopilot Values

Table 37 Description of the Quality Indicators according to IEC 62288

No.	Area / Element	Description
1	SET HEADING / SET COURSE	Displays the set heading or course that was set via the NautoPilot® or the Additional Autopilot Control.
2	SET RADIUS / SET RATE	Displays the set turn radius in NM or the set Rate of Turn in degrees that was set via the NautoPilot® or the Additional Autopilot Control Unit.
3	USED SPEED	Displays the used speed and the sensors that supply the data: WT = Water Track (Log) BT = Bottom Track (GPS / Doppler Log)
4	RUDDER LIMIT	Displays the set Rudder limit.
5	Colored Quality	See: Description of the Quality Indicators according to IEC 62288 (Table 34).

5.2.4 Menu

Table 38 Menu Bar Content

Designation	Function
Color Palettes	Change color mode.
Dimming	Change dimming adjustment.
Setting	Change system and profile configuration.
Login	Login with different user mode.
Exit	Exit this application.

For more information see SYNOPSIS NX manual.

5.2.5 Panel

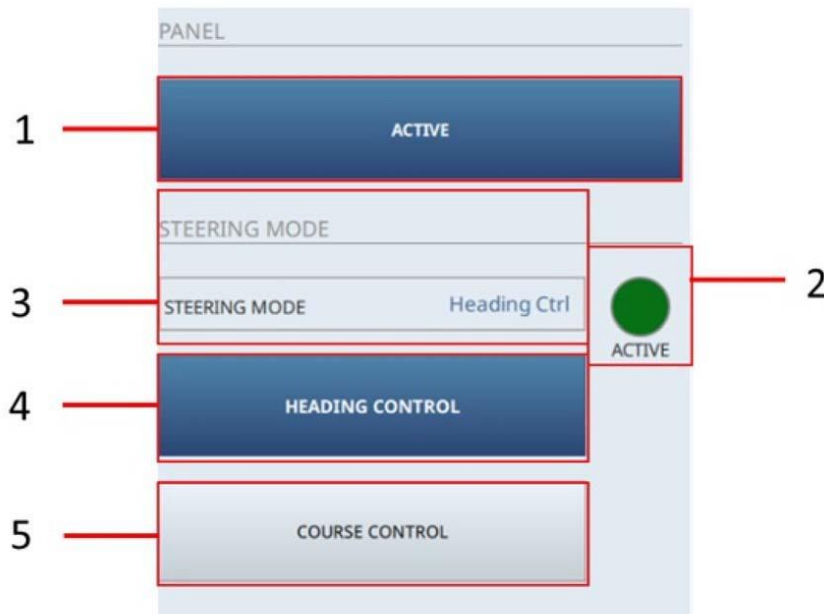

Figure 61: Section Panel

Table 39 Section Panel

No	Designation	Function
1	Softkey ACTIVE	Activates the panel. The NautoPilot® is under control off the Additional Autopilot Control Unit.
2	Indicator lamp	Green = The NautoPilot® and Additional Autopilot Control Unit is active. Orange = The Additional Autopilot Control Unit is not active (standby). No Color = manual mode (OFF)
3	STEERING MODE	Displays the current steering mode. - HEADING CONTROL - COURSE CONTROL - TRACK CONTROL - Manual
4	Softkey HEADING CONTROL	Activates the steering mode heading control.

5	Softkey COURSE CONTROL	Activates the steering mode course control.
---	------------------------	---

5.2.6 Control

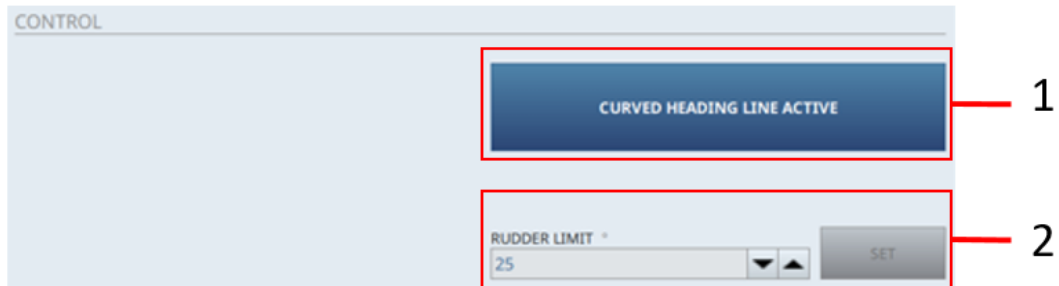

Figure 62: Section Control

Table 40 Section Control

No	Area / Element	Description
1	Softkey Curved Heading Line ACTIVE	Activates the Curved Heading Line (CHL). The CHL is displayed in the Raytheon SYNOPSIS NX ECDIS and RADAR systems.
2	RUDDER LIMIT	Set the rudder limit via the on-screen numerical pad or via the softkeys ▲ and ▼ in 1° steps.

The settings are displayed in the section AUTOPILOT VALUES.

5.3 Using the Joystick



Figure 63: Joystick

The Joystick operates like the control panel in the section CONTROL. It is movable in 4 directions: Forwards, backwards, right and left.

Commands can either be given with a movement in the respective direction, whereby the value changes by one unit, or it can be held in one direction, whereby

the value changes until the joystick is brought back to its initial position.

Table 41 Joystick operation

Direction	One movement	Held in
Forwards (Rad +)	The turning radius increases 0.1 NM	Changes of the values until released.
Backwards (Rad-)	The turning radius reduces 0.1 NM	Changes the course or heading to be steered until released.
Left (Port)	Changes the course or heading to be steered 1° to port. Note: If a course with a decimal value (e.g. 315.7°) is still set, this value is rounded off the first	Changes the course or heading to be steered until released.
Right (Stbd)	Changes the course or heading to be steered 1° to starboard. Note: If a course with decimal value (e.g. 315.3°) is still set, this value is rounded up with the first movement.	Changes the course or heading to be steered until released.

The settings are displayed in the section AUTOPILOT VALUES.

5.4 Operation

With the Additional Autopilot Control Unit, it is possible to control the NautoPilot® in the modes:

- Heading Control
- and Course Control.

NOTE: No Track Control able.

The Track Control mode is started by a track planning system (ECDIS, Raytheon Anschutz). See chapter 4.5.1

5.4.1 Heading Control

Procedure:

1. Select the softkey ACTIVE in the section PANEL.
2. The softkey is highlighted and the indicator lamp lights green.
3. Select the softkey HEADING CONTROL in the Section PANEL.
4. The softkey is highlighted and the STEERING MODE displays Heading Ctrl. or if the panel is not active and Manual Control is active, you can also press Heading Control directly.

-

Step result:

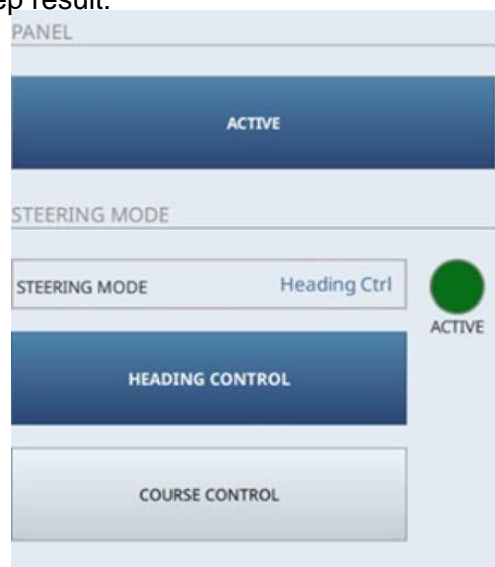

5. Set the desired heading and radius by using the joystick.

5.4.2 Course Control

Procedure:

1. Select the softkey ACTIVE in the section PANEL.
2. The softkey is highlighted and the indicator lamp lights green.
3. Select the softkey COURSE CONTROL in the Section PANEL.
4. The softkey is highlighted and the STEERING MODE displays Course Ctrl.

Step result:

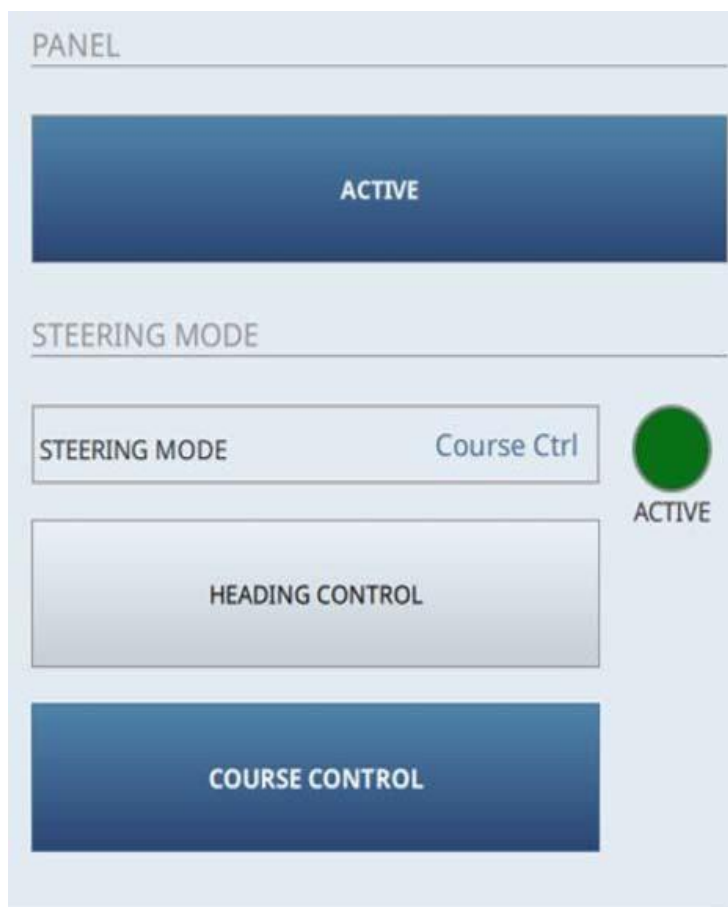

5. Set the desired heading and radius by using the joystick

5.5 Set Rudder Limit

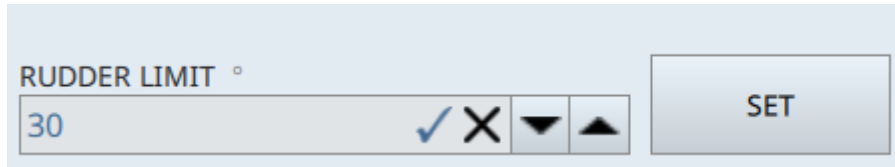

Select the entry field RUDDER LIMIT in the Section CONTROL. The softkey **SET** switches to active.

Enter the required value via the on- screen numerical pad or via the softkeys ▼ and ▲ .

Confirm the entries with the check mark and then with the softkey **SET**.

The Settings are displayed in the section AUTOPILOT VALUES.

If an invalid value is entered, the values cannot be confirmed as shown in the example below:

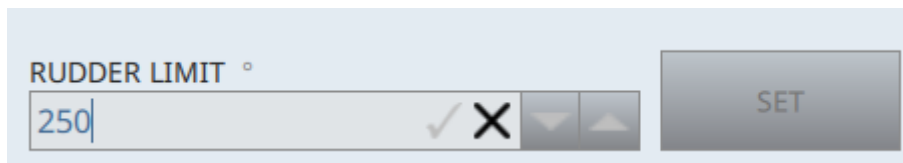

If no entry is made or the entry is not confirmed after 15 seconds, the previous settings are retained.

5.6 Alerts of the Additional Autopilot Control Unit

Alerts are given acoustically and are shown on the NautoPilot® Operator Unit, ECDIS and Radar.

For more Information see chapter 7 Alert/status message handling for NautoPilot® and the chapters Alert Area and Alert Management in the Software Manuals of ECDIS and Radar.

If the data transfer fails in Heading Control Mode, this alarm appears in the field AUTOPILOT VALUES. The NautoPilot® main unit takes control again. In this case the Additional Autopilot Control Unit goes into standby mode. If the failure has been corrected, the Heading Control Mode must be selected again, see 5.4.1 Heading Control.

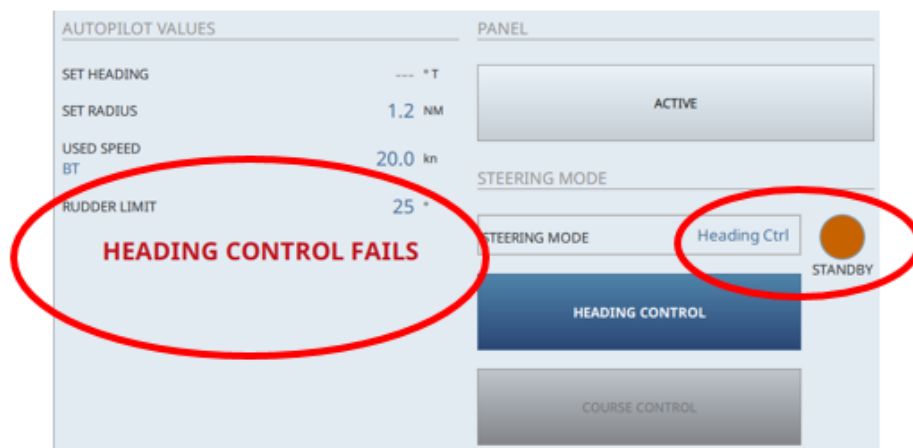

5.7 Show / Hide the Curved Heading Line

Select the softkey CHL ACTIVE in the Section CONTROL. The softkey is highlighted and the Curved Heading Line is displayed on the RADAR and ECDIS.



Select the softkey again to hide the Curved Heading Line. The softkey is not highlighted.

5.8 Switching between night and day display (dimming) Change Display Colors

The display can be configured for different conditions by changing the color combinations.

Following color modes are available:

- Bright Sun Colors Bright on white background
- Day Colors - White Dark on white background
- Day Colors - Black Bright on black background
- Dusk Colors Fluorescent on black background
- Night Colors Fluorescent dim on black background

Procedure:

1. Select *Menu* from the top right corner of the display:
 - The submenu opens.
2. Select Color Palettes.
 - The drop- down menu opens.
3. Select the desired color mode.
 - The color combination on the screen changes.

5.9 Adjust Dimming

- Select *Menu* from the top right corner of the display.
-- The *Menu* submenu opens.
- Select Dimming.
The Dimming menu opens.



- Select Central or Local with the switch-button.
- Adjust the dimming level with the slider.

6 Superior operation features

6.1 Changing the license key

This function is identical to a NautoPilot® Operator Unit upgrade.



A check/reconfiguration should be performed after changing a license key.

See the Service Manual for the NautoPilot® Operator Unit

6.2 Software update



A software update should be performed only by experienced and well- trained personnel.
A configuration check should be performed after a software update.

See the Service Manual for the NautoPilot® Operator Unit

6.3 Handling of more than one NautoPilot® Operator Unit in a steering system (Master - Slave - application)

It is possible to install more than one NautoPilot® Operator Unit in a steering system. However, only one of the NautoPilot® Operator Units is a master, whilst the others are designated as slaves.

A slave NautoPilot® Operator Unit can be switched into active mode or inactive mode. If a slave is active all other NautoPilot® Operator Units in a steering system are inactive, even the master NautoPilot® Operator Unit (except its calculation task). OU Display (see also section 6.3.1) is indicated at the inactive NautoPilot® Operator Units, at the top right corner of the display (above the control mode).

Figure 64: Master- and Slave NautoPilot® Operator Units.

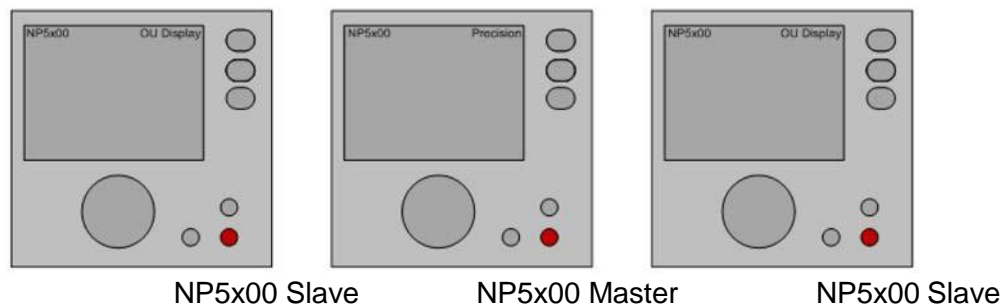

Only the master NautoPilot® Operator Unit performs (calculates) the control function of a steering control system. The active slave NautoPilot® Operator Unit serves for data/ value input and visual monitoring only - all inputs, as well as configuration values, can be performed.

The lower LED (below the Heading, Course or Track buttons) can only light up yellow at inactive NautoPilot® Operator Units for steering systems with more than one NautoPilot® Operator Unit.

An acknowledgement of alarms/status messages is possible at all NautoPilot® Operator Units (independent of master or slave).



Exceptions or additional information to applications with several NautoPilot® Operator Units are given in the corresponding sections.



Please note:

Central Dimming cannot be executed by slave NautoPilot® Operator Units.

Dimming changes can only be executed locally at each slave NautoPilot® Operator Unit.

Figure 65: Principle of master slave NautoPilot® Operator Unit

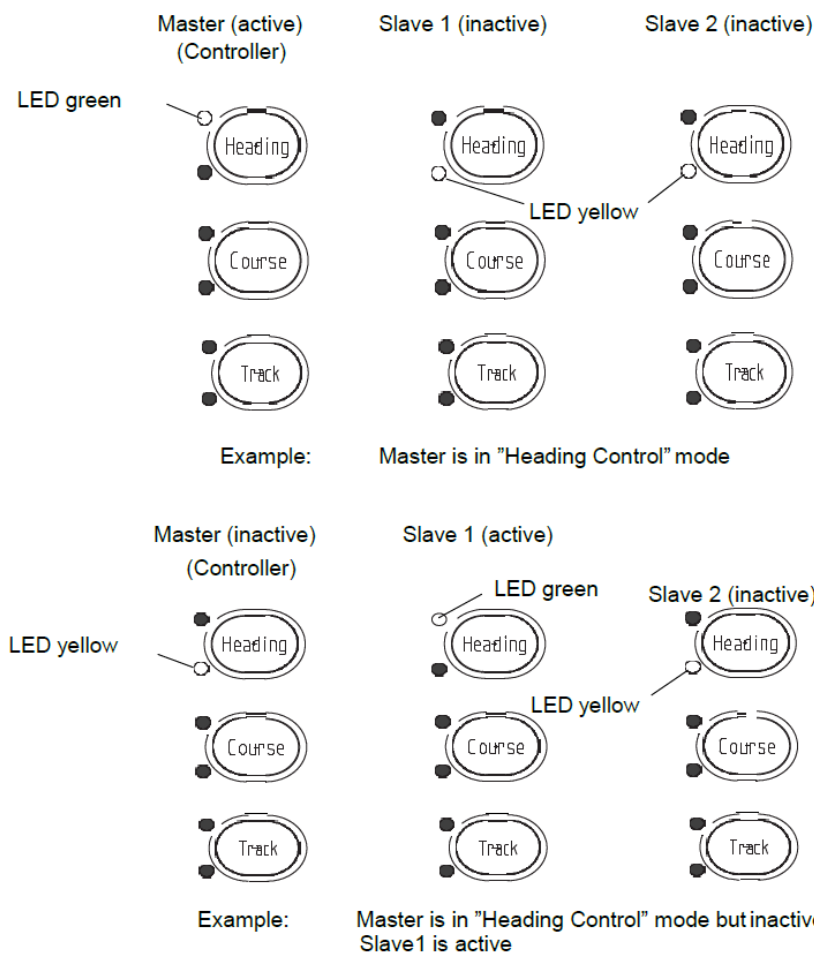

This principle is the same for Heading Control mode, Course Control mode and

for Track Control mode.

General information:

At the active NautoPilot® Operator Unit a green LED is on at the corresponding mode button.

At the inactive NautoPilot® Operator Units a yellow LED is on at the corresponding mode button.

Green LED (off) and yellow LED (off) show the Manual mode. Green LED (off) and yellow LED (on) show the Standby mode.

6.3.1 OU Display indication

This information is displayed at an inactive NautoPilot® Operator Unit only if there are more than one NautoPilot® Operator Units in a steering system (refer to Figure 59).

It means that this NautoPilot® Operator Unit serves only as a display.

At this NautoPilot® Operator Unit no inputs are possible (except acknowledgement of messages in the message bar).

But a selection of other displays is possible.



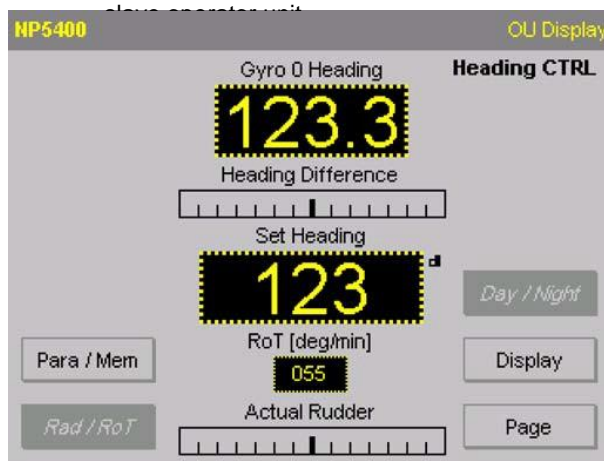

Figure 66: Indication "OU Display" in



6.3.2 Procedure to change NautoPilot® Operator Unit status (active - inactive)

This procedure is independent of master or slave NautoPilot® Operator Unit.







Table 42 Procedure to change NautoPilot® Operator Unit status (active - inactive) without change of control mode

<u>Without a change of the control mode:</u>	
<p>Green LED</p> 	<p>"Heading Control" mode is selected at the active NautoPilot Operator Unit. The green LED is on.</p>
<p>Yellow LED</p> 	<p>The yellow LED at the inactive NautoPilot Operator Units shows the selected control mode. The top right corner of the display shows "Heading Control".</p>
<p>Yellow LED</p> 	<p>Pressing the control mode button at the inactive NautoPilot Operator Unit causes this unit to become active. The alert "Active Operator Unit Changed" is displayed.</p>
<p>Green LED</p> 	<p>The prior inactive NautoPilot Operator Unit is now active. The corresponding status message at the message/alarm bar is displayed.</p>

Please note:

- It is necessary to observe the Autopilot control function after this procedure.

Table 43 Procedure to change NautoPilot® Operator Unit status (active - inactive) with change of control mode

<u>With a change of the control mode:</u>	
<p>Green LED</p> 	<p>Active NautoPilot Operator Unit:</p> <p>The "Heading Control" mode is selected at the active NautoPilot Operator Unit.</p> <p>The green LED is on.</p>
<p>Yellow LED</p> 	<p>Inactive NautoPilot Operator Unit:</p>
<p>No LEDs are on at the control mode button (of the control to be selected) at the inactive NautoPilot Operator Units.</p> 	<p>No LEDs are on at the control mode button (of the control to be selected) at the inactive NautoPilot Operator Units.</p>
<p>Pressing the control mode button "Course" at the inactive NautoPilot Operator Unit activates this unit.</p> 	<p>Pressing the control mode button "Course" at the inactive NautoPilot Operator Unit activates this unit.</p> <p>The alert "Operator Unit is not active! Activate now?" is displayed.</p> <p>Confirm by pressing "Set".</p>
<p>Green LED</p> 	<p>But this NautoPilot Operator Unit is in now in "Heading Control" mode. The Autopilot remains in initial control mode.</p> <p>Please note: A change of NautoPilot Operator Unit status (active - inactive) together with a change of control mode is <u>not</u> possible.</p>
	<p>Pressing the control mode button "Course" at the (now) active NautoPilot Operator Unit changes the control mode.</p>

Please note:

- It is necessary to observe the Autopilot control function after this procedure.



If an active slave fails (no power), the system will automatically switch over to the master NautoPilot® Operator Unit.

If a master fails (no power), no switchover is performed, there is no Autopilot control mode possible, therefore a manual mode (handwheel or tiller) must be activated.

6.4 Handling of more than one NautoPilot® Operator Unit in a steering system (Master - Master - application)

It is possible to install more than one Master NautoPilot® Operator Unit in a steering system (if there are 2 or more complete independent steering positions - for example).

6.4.1 Specifics for a Master - Master - Application

- § Each NautoPilot® Operator Unit is complete independent, with own sets of parameters and adjustments.
- § Each NautoPilot® Operator Unit must be switched on separately for usage. Both (or more) NautoPilot® Operator Units must be switched on for operation.
- § A switching over (Master to Master) is possible only in Heading Control mode of the Source- Master.
The Destination- Master starts in Heading Control mode and controls with its own parameters and adjustments.
- § Occurred alerts are **not** transmitted from the Source- Master to the Destination- Master.
- § A switching over with an Override function is performed to the last active Master only.
If this Master is currently not active, an alarm is generated at an Override Signal Unit.
- § A switching over is performed only by activation of the other Autopilot Operator Unit (pressing the Heading button).
- § Each NautoPilot® Operator Unit must be operated separately according to this manual.

Intentionally left blank

7 Alert/status message handling



Please note:

It is advisable to acknowledge each warning, caution and information message.

It is strongly advisable to acknowledge each alarm and to resolve its cause before continuing with a control mode.



Please note:

There are two ways to display alerts.

- Short text

- Long text

Short text is for acknowledged alerts, but the cause is still present.

Long text is for unacknowledged alerts.

Alert messages that are unacknowledged but still active are escalated. Based on priority and category, the following escalations are possible:

- The alert is repeated
- The alert is escalated as an alarm
- The alert is escalated as an alarm and transferred to BNWAS (if available)

Escalation will occur after 1 minute if not otherwise required by the standard.

For more information see the Alert List in chapter 8 Annex.

Figure 67: Alert messages at the NautoPilot® Operator Unit (example for long text)



Figure 68: Alert messages at the NautoPilot® Operator Unit (example for short text)



Alarms and warnings are displayed alphanumerical in the red or yellowish orange top bar of the display (see Figure 63). The icon of the alert flashes until the ACK button is pressed (acknowledgement).



Please note:

In order to avoid unintended acknowledgement of a new incoming alert, the push button ACK is deactivated for 1 second after receiving a new alert.

Alarms, warnings or cautions are displayed together with an alert icon (see section 7.1)

NautoPilot® 5000 is not able to silence alerts. Silencing is only possible with CAM.

When an alert occurs for the first time, it is displayed with the long text.
After acknowledgement, the first line of the short message is displayed.
After the cause for a message is eliminated, the message is no longer displayed.

Additional information about the cause of an alert (example: Track Control Interrupted - No Position) at the top bar of the display toggles between both text lines.

The NautoPilot® 5000 supports the responsibility take over functionality as defined in IEC 62923-1.

The display of incoming alerts is delayed by 4 seconds in order to allow responsibility transfer before activating optical and acoustical signals.

The NautoPilot® 5000 accepts responsibility transfer from external systems using the alert communication as defined in IEC 62923-1 for category B alerts. The responsibility of category A alerts cannot be transferred to external systems.

The NautoPilot® 5000 itself does not request responsibility from external systems.

Table 44 Alarms/messages alerts

Color	Meaning - visual	Acoustic signals
Red (Alarm) flashing	Alarms (faults and/or dangerous situations)	3 short signals (pulses), every 7 seconds. Continues until acknowledgement.
yellowish orange (Warning) flashing	Warnings	2 short signals (pulses) after the event without repetition.
yellow (Caution)	Status messages Information	There is no acoustic signal for status and global messages.

(see also Table of alert icons, section 7.1)

In addition to the acoustic signal, the (red) ACK LED flashes.

The acoustic signal has both a low volume signal and a loud signal (from 2 different signal horns).



Please note:

It is also possible to acknowledge alerts at an inactive NautoPilot® Operator Unit.

Each alert is combined with a priority. This priority is generated by the NautoPilot® Operator Unit and depends on the operating mode, operating status and severity.

Each alarm or warning must be acknowledged with the ACK button.

If several alerts occur, the one with the highest priority is displayed at the bar (short text). Priority of alerts is set internally. After pressing the ACK button all alerts are displayed (one after another for approx. 3 seconds). After pressing the ACK button again the alert with the highest priority is shown.

If an alert consists of more than 1 text line, those will be displayed one after another. In this case the alerts will also be numbered [1], [2],...

If the cause which leads to an alarm or a warning is eliminated without acknowledgement (pressing the ACK button), the acoustic signal stops and the alarm will be given lowest priority.

The table in the annex shows all possible messages, their possible cause and recommendations for corrective action.



Please note:

Cautions and information messages do not necessarily have to be acknowledged. They are no longer displayed if their cause is no longer present.







7.1 Alert Management Icons





Below mentioned table shows the alert / warning or caution icons which are displayed at the top bar of the display. These icons are based on the IEC 62923-1:2018.



Please note:
 It is only possible to display messages with an APIF add-on if there is an autopilot interface connected (standalone application) and the NautoPilot® operator unit is configured for such an application.

Table 45 Alert management icons

Icon name	Icon description and remarks	Icon (graphics)
Active – unacknowledged alarm	A flashing red triangle. A symbol of loudspeaker in the middle of the triangle. This icon is presented together with the alert text and with an acoustical sound (3 times every 7 second).	
Active – silence alarm	A flashing red triangle. A symbol of loudspeaker with a prominent diagonal line above it. This icon is presented together with the alert text.	
Active – acknowledged alarm	A red triangle. An exclamation mark in the middle of the triangle. This icon is presented together with the alert text.	
Active – responsibility transferred alarm	A red triangle. An arrow pointing towards the right in the middle of the triangle. This icon is presented together with the alert text. In the meaning of: This alarm is automatically acknowledged.	
Rectified – unacknowledged alarm	A flashing red triangle. A tick mark in the middle of the triangle. This icon is presented together with the alert text.	
Active – unacknowledged warning	A flashing yellowish orange circle. A symbol of loudspeaker in the middle of the circle. This icon is presented together with the alert text and with an acoustical sound (once 2 times on occurrence).	
Active – silence warning	A flashing yellowish orange circle. A symbol of loudspeaker with a prominent diagonal line above it. This icon is presented together with the alert text.	

Icon name	Icon description and remarks	Icon (graphics)
Active - acknowledged warning	A yellowish orange circle. An exclamation mark in the middle of the circle. This icon is presented together with the alert text.	
Active - responsibility transferred warning	A yellowish orange circle. An arrow pointing towards the right in the middle of the circle. This icon is presented together with the alert text. In the meaning of: This warning is automatically acknowledged.	
Rectified - unacknowledged warning	A flashing yellowish orange circle. A tick mark in the middle of the circle. This icon is presented together with the alert text.	
Caution	A yellow square. An exclamation mark in the middle of the square. This icon is presented together with the alert text.	

7.2 Possible alarms, warnings and cautions



Please note:
 Messages/alarms with the "APIF" add-on are only possible if an Autopilot Interface is installed (standalone application) and the NautoPilot® Operator Unit is configured for an application with an Autopilot Interface.

For a detailed description of alarms, warnings and cautions, see alert list in the annex.

7.3 Other alarms

The next sections show alarm and warnings which are either transmitted to a central alarm panel as Central Alarm or combined as part of a System Alarm.

7.3.1 Central alarm

(For some classification societies only).

The NautoPilot® 5000 poses as the backup for the CAM display as defined in IEC 62923-1.

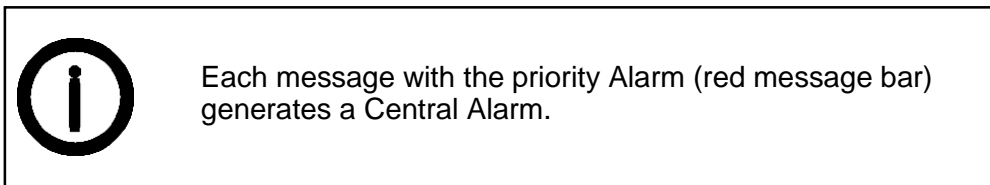

For standalone application only - with Autopilot Interface:

The alarms described below are shown in the NautoPilot® Operator Unit message bar. They are transmitted simultaneously to the Autopilot Interface and generate a Central Alarm at plugs B17 and B36 of the Autopilot Interface.

The possible cause and the respective corrective action are shown in Table 43.

For AS Application:

In an AS application with an Alarm Status Interface AS (type 138- 130) the Central Alarm is output at the Alarm Status Interface.

7.3.2 System alarm

The alarms described below are shown in the NautoPilot® Operator Unit message bar. They generate a system fail at the Plug B3 of the NautoPilot® Operator Unit.

These alarms mean that the NautoPilot® Operator Unit is disrupted in such a way that basic functions cannot be performed.

The possible cause and the corrective action are shown in Table 43.









Alarms can be:

- Power Failure
- No Heading
- Simulated sensor data
- Missing n APIs
- Too many APIs on the CAN bus, please check configuration
- The Autopilot has performed an automatic Reset

The first action to take when one of the above alarms has been activated should be to reset the NautoPilot® Operator Unit either by switching OFF the supply voltage or by re- moving the fuse at the rear.

7.3.2.1 Specials on Heading Failure

When the heading returns after a heading failure, the last Set Heading will be suggested as new Set Heading and the Set LED flashes. Heading controller is set off work and rudder will remain at actual rudder angle until either a new Set Heading is selected and acknowledged (press Set button) or the steering mode is changed.

An alert is displayed at the top bar of the display (see section 6).		
	<p>CHECK SET HEADING</p> <p>Select a new Set Heading _____</p> <p> 3 pulses repeated every 7 seconds</p>	
	Only after the heading value is checked or changed and the button Set is pressed, it is possible to acknowledge this alarm.	
	 	
Acknowledge the alert.		
	 	

8 Annex

8.1 Alerts

8.1.1 Alert List

Note

Messages / alarms with the APIF add-on are only possible if an autopilot interface is installed (standalone application) and the NautoPilot® Operator Unit is configured as an application with an autopilot interface.

Tab. 11: Alerts APIF

Alert Title Alert Description	Category Priority	Escalation	Possible Cause	Remedy
OVERRIDE APIF: EXTERNAL AUTOPILOT OVER- RIDE	Alarm B		External override is triggered.	
RUD. STOPPED APIF NO ACTU- AL RUDDER: USE MANUAL STEERING	Alarm B		Missing rudder feed- back information from CAN. Rudder is frozen.	Check APIF Manual, use manual steering.
RUD. STOPPED. APIF ANALOG FEEDBACK: USE MANUAL STEERING	Alarm B		Missing analog rudder feedback. Rudder is frozen.	Check APIF Manual, use manual steering.
RUD. STOPPED APIF CONFIG FAILED: USE MAN- UAL STEERING	Alarm B		APIF Configuration corrupted. APIF SYS FAIL and Rudder is frozen.	Check APIF Manual, use manual steering.
RUD. STOPPED APIF SET RUDDER FAIL: USE MANUAL STEERING	Alarm B		APIF has not re- ceived a valid Set rudder. Rudder is frozen.	Check APIF Manual, use manual steering.

Alert Title Alert Description	Category Priority	Escalation	Possible Cause	Remedy
APIF RESTART APIF SOFTWARE RESTART: CHECK APIF	Warning B		APIF was restarted by internal watchdog.	Check APIF Manual.
RUD. STOPPED APIF CAN BUS FAILURE: USE MANUAL STEERING	Warning B	as Warning	No CAN-connection between APIF and Feedback Unit. Rudder is frozen.	Check APIF Manual, use manual steering.
STEER. FAIL. APIF STEERING FAILURE: USE MANUAL STEERING	Warning B		APIF has detected a difference between set and actual rudder exceeding the config- ured limit. Should occur only if APIF is controlling the rudder.	Check APIF Manual, use manual steering.
SYSTEM FAIL. APIF DA CONVERT- ER FAIL: USE MAN- UAL STEERING	Warning B		D/A-Failure detected during self-test or sig- nal fault discovered.	Check APIF Manual, use manual steering.
SYSTEM FAIL. APIF FRAM FAIL: USE MANUAL STEERING	Warning B		APIF FRAM not ac- cessible. APIF SYS FAIL. Rudder is frozen.	Check APIF Manual, use manual steering.
SYSTEM FAIL. APIF POW- ER FAILURE: USE MANUAL STEERING	Warning B		APIF Power failure. APIF SYS FAIL.	Check APIF Manual, use manual steering.
CAN 1 FAIL APIF: USING BACK- UP CAN2: CHECK WIRING	Caution B		Communication er- ror using CAN1, on- ly CAN2 as backup available.	Check CAN connec- tion.
CAN 2 FAIL APIF: USING BACK- UP CAN1: CHECK WIRING	Caution B		Communication er- ror using CAN2, on- ly CAN1 as backup available.	Check CAN connec- tion.

Alert Title Alert Description	Category Priority	Escalation	Possible Cause	Remedy
GYRO FAILED APIF GYRO HEADING FAILED: CHECK HDG SENSOR	Caution B	none	Gyro connected at APIF failed.	Check Gyro connected to APIF.
GYRO FAILED APIF GYRO: SELECT OTHER HEADING SENSOR	Caution B		Gyro connected at APIF failed.	Check Gyro connected to APIF.
HCS UNAVAIL. APIF FAILURE: CHECK APIF	Caution B		APIF is not responding, AP is in standby.	Check APIF.
MAG FAILED APIF MAGNETIC HDG FAILED: CHECK SENSOR	Caution B		Magnetic compass connected to APIF failed.	Check magnetic compass connected to APIF.
POS FAILED APIF POSITION FAILED: CHECK SENSOR	Caution B	none	Position sensor connected to APIF failed.	Check position sensor connected to APIF.
SPD FAILED APIF SPEED SENSOR FAILED: CHECK SPEED SENSOR	Caution B		Speed sensor connected to APIF failed.	Check speed sensor connected to APIF.

Tab. 12: Alerts HDG Control

Alert Title Alert Description	Category Priority	Escalation	Possible Cause	Remedy
FORCED TO MAN NO STEERING MODE: USE MANUAL STEERING	Alarm B		Status of Steering selector switch is not available.	Use manual steering, check steering selector switch, check CAN-BUS.
HCS STOPPED NO HEADING: CHECK HEADING SENSORS	Alarm B	to BN-WAS (30 s)*	No heading information available, heading control remains active but rudder is frozen.	Use manual steering, check heading sensors.

Alert Title Alert Description	Category Priority	Escalation	Possible Cause	Remedy
HCS STOPPED POWER FAILURE: CHECK POWER SUPPLY	Alarm B		Power supply of the operator unit is outside of tolerable limits.	Use manual steering. Check supply voltage. Reset operator unit. Replace Operator unit.
SIM SENSOR DATA SIMULATED SENSOR DATA IN USE: CHECK SENSORS	Alarm B		Sensor data received which is tagged as simulated.	Check connected sensors, use manual steering.
ACCEL. EXC ACCELERATION LIMIT EXCEEDED: REDUCE SPEED	Warning B		User adjusted acceleration limit exceeded	Reduce Speed, control limit
ACCEL. LIMITD ACCELERATION LIMIT EXCEEDED: REDUCE SPEED	Warning B	as Warning	Operator adjusted acceleration limit was exceeded.	Reduce Speed, control adjusted limit
ACT. OU FAIL CHECK AP OPERA- TOR UNIT	Warning B		Active Operator reports a failure	Use manual steering, check Operator unit
HEADING DEVIATED FROM SET HEADING: TAKE HELM	Warning A	as Alarm to BN- WAS (30 s)*	Offset between actual and set heading exceeds operator adjusted off heading limit.	Check surroundings, use manual steering, check rudder limit, check steering system
HDG DOUBTFUL HDG DIFFERENCE DETECTED: CHECK HDG SENSORS	Warning B	as Warning	Heading monitor has detected a difference between two heading sources. The operator adjusted off heading limit was exceeded.	Check heading sensors.
HDG JUMPED CHECK ACTUAL AND SET HEADING	Warning B	as Warning	A jump in the heading data was detected.	Check set heading, check heading sensors.
LOW SPEED CTRL ACCURACY LIMITED: USE MAN- UAL STEERING	Warning B	as Warning	Current speed is below adjusted low speed limit. Control accuracy is degraded.	Increase speed, use manual steering.

Alert Title Alert Description	Category Priority	Escalation	Possible Cause	Remedy
MAG FAILED BACK UP HDG SENSOR FAILED: CHECK SENSOR	Warning B	as Warning	Backup magnetic heading sensor failed.	Check magnetic heading sensor.
MAG HDG SEL. MAGNETIC HEADING USED FOR HEADING CONTROL	Warning B	as Warning	Magnetic heading sensor selected for heading control.	
NO VALID SPD SWITCH TO VALID SPEED SOURCE	Warning B	as Warning	No valid speed available.	
POS VALID POS AVAILABLE: SWITCH TO VALID POSITION	Warning B	as Warning	Valid position available.	Select the position sensor
RUDDER LIMIT RUDDER LIMIT REACHED	Warning B	as Warning	Rudder reached the operator adjusted rudder limit.	
SPD IS VALID VALID SPEED AVAILABLE: SWITCH SPD SOURCE	Warning B	as Warning	Valid speed available	Select the speed sensor.
SPEED JUMPED SPEED JUMP DETECTED: CHECK SPEED SENSOR	Warning B	as Warning	Speed jump detected.	Check speed sensors.
ACT. FAIL DEVICE ACTIVATION NOT POSSIBLE	Caution B	none	Heading control not activated, No rudder control was transferred to Autopilot	Check steering system.
BACKUP GYRO FAIL NO BACKUP GYRO AVAILABLE	Caution B	as Warning	A backup gyro sensor has reported an error.	Check backup gyro sensor.

Alert Title Alert Description	Category Priority	Escalation	Possible Cause	Remedy
CHECK LIMITS CHECK RUD- DER/ROT/RAD LIMITS	Warning B	as Warning	Track control was interrupted.	The operator shall check the limits for RAD/ROT and Rudder limits. Those might have changed by the TCS.
HCS UNAVAIL. NO HEADING: CHECK HEADING	Caution B		Autopilot in standby, but no heading data available. Heading control cannot be activated.	Check Heading sensors.
HCS UNAVAIL. POWER FAILURE: CHECK POWER SUPPLY	Caution B	none	Power supply of the operator unit is outside of tolerable limits, the device is in standby mode	Check power supply.
HCS UNAVAIL. NO STEERING MODE: USE MANU- AL STEERING	Caution B		Status of Steering selector switch is not available. AP is in standby and cannot be activated.	Check steering system.
HCS UNAVAIL. APIF: AUTOPILOT ACTIVATION FAILED	Caution B		AP was not activated.	
HCS UNAVAIL. CANNOT ACTIVATE HCS: USE MANUAL STEERING	Caution B		Unexpected behaviour in case of giveover of rudder control by steering system. Heading control not activated.	
HDG CHANGE SENSOR USED FOR CONTROL FUNCTION CHANGED	Caution B	none	Automatic change of selected heading sensor.	
HDG DOUBTFUL FUNCTION NOT ACTIVATABLE	Caution B	none		

Alert Title Alert Description	Category Priority	Escalation	Possible Cause	Remedy
HDG MON DIS. HEADING MONITOR DISABLED	Caution B	none		
HDG UNCORR. CHECK HEADING CORRECTION	Caution B	none	Gyro reports uncorrected heading information.	Check Gyro
INP NOT ACCEPTED INPUT NOT ACCEPTED: REPEAT INPUT	Caution B	none	Inplausible Input, e.g. Set Heading.	Repeat input.
LOW SPEED CTRL ACCURACY MAY BE LIMITED	Caution B		Autopilot in standby and current speed is below adjusted low speed limit.	none necessary. Increase speed prior to activating Heading control.
MAG FAILED BACK UP HDG SENSOR FAILED: CHECK SENSOR	Caution B	none	Magnetic compass connected to AP failed.	Check magnetic compass.
NO BACKUP GYRO NO BACKUP GYRO AVAILABLE	Caution B	none	Backup gyro reports failure.	Check backup gyro
NO RUD. CTRL NO RUDDER CTRL ON CAN: USE MANUAL STEERING	Caution B		Take over of rudder control not successful.	Check steering system.
NO SET HDG SET HDG REJECTED: ENTER NEW SET HEADING	Caution B	none	Error during set heading adjustment	Repeat set heading adjustment
NOT SPD ADAPTIVE NO SPEED ADAPTIVITY: CHECK SPEED SENSOR	Caution B	none	No speed information available.	Check speed sensors, adjust manual speed.
OU CHANGE ACTIVE OPERATOR UNIT CHANGED	Caution B	none	Another OU was activated and is now the active OU.	

Alert Title Alert Description	Category Priority	Escalation	Possible Cause	Remedy
POS CHANGED POSITION SENSOR CHANGED	Caution B	as Warning		
POS INVALID SWITCH TO VALID POS SOURCE	Caution B	none	Selected Position sensor sends no or invalid data.	Select valid position sensor, check position sensor
REM. OU FAIL CHECK REMOTE OPERATOR UNITS	Caution B		An additional OU has reported an error.	Check remote operator units.
SPD CHANGED SPEED SENSOR CHANGED	Caution B		Selected speed sensor was changed automatically.	

Tab. 13: Alerts Track Control

Alert Title Alert Description	Category Priority	Escalation	Possible Cause	Remedy
CRS CHANGE CHANGING TO 000°	Warning A	as Alarm to BN- WAS		
END OF TRACK CHANGE STEERING CONTROL MODE	Warning A	as Alarm to BN- WAS (30 s)*	Approaching Track end warning was not raised and end of track passed, course of last leg is maintained.	Change control mode to heading control or use manual steering.
END OF TRACK END OF TRACK IN 000min	Warning A	as Alarm to BN- WAS (30 s)*	End of Track passed, course of last leg is maintained.	
NEW CRS 30S COURSE CHANGE IN 30 SECONDS	Warning A	as Alarm to BN- WAS (30 s)*	Actual change warning if AP is configured for IEC62065:2014.	Acknowledge warning, Check maneuver.

Alert Title Alert Description	Category Priority	Escalation	Possible Cause	Remedy
NEW CRS 3MIN COURSE CHANGE IN 3 MIN	Warning A	as Alarm to BN- WAS (30 s)*	Next leg change is due in 3 min- utes. Track control IEC62065:2014	Acknowledge warn- ing, Check maneuver.
NO SPEED TURN RADIUS MAY NOT MATCH	Alarm B	to BN- WAS	No speed information during Track control. May result in less ac- curate control, espe- cially during turns.	Check speed sen- sors, adjust manual speed.
POS INVALID SWITCH TO VALID POSITION SOURCE	Warning B	as Warning	No valid position available.	
TCS STOPPED NO HEADING: USE MANUAL STEERING	Alarm B	to BN- WAS (30 s)*	Track control stopped due to missing head- ing information, HDG control is active as fallback but rudder is frozen.	Use manual steering, check heading sen- sors
TCS STOPPED HDG INTEGRITY: CHECK HEADING SENSORS	Warning B	as Alarm to BN- WAS (30 s)*	Track control stopped due to doubtful head- ing information. Selected HDG differs from reference sen- sors or only one HDG sensor is available	Check heading sen- sors, use HDG Con- trol or manual steer- ing
TCS STOPPED POWER FAILURE: CHECK POWER SUPPLY	Warning B	as Warning	OU Power failure de- tected while in Track control	Check power supply.
TCS STOPPED CHANGE ANGLE TOO BIG CHECK ROUTE	Warning B	as Alarm to BN- WAS (30 s)*	Track control was in- terrupted. Heading change to next leg implausible.	Check route.
TCS STOPPED NEXT WPT TOO CLOSE	Warning B	as Alarm to BN- WAS (30 s)*	Track control was in- terrupted. Distance between To and next waypoint is too close.	Check route.

Alert Title Alert Description	Category Priority	Escalation	Possible Cause	Remedy
TCS STOPPED DISTANCE TO WPT TOO SHORT	Warning B	as Alarm to BN- WAS (30 s)*	Track control interrupted. Distance between From and To waypoint too close or selected Waypoint to start track control is too close.	Check route.
TCS STOPPED CHECK GOTO WAYPOINT	Warning B	as Alarm to BN- WAS (30 s)*	Trying to activate Track control while not within heading cone	Check route.
TCS STOPPED CHECK GOTO WAYPOINT	Warning B	as Alarm to BN- WAS (30 s)*	Trying to activate Track control while not within necessary sector	Check route.
TCS STOPPED MISSING WAY- POINT	Warning B	as Alarm to BN- WAS (30 s)*	NP5500 only: Missing waypoint in the waypoint list received from the ECDIS.	Check connection to ECDIS
TCS STOPPED INVALID INFOR- MATION FROM ECDIS: CHECK ECDIS	Warning B	as Alarm to BN- WAS (30 s)*	ECDIS Status is missing.	Check connection to ECDIS
TCS STOPPED TOO CLOSE TO WAYPOINT	Warning B	as Alarm to BN- WAS (30 s)*	Activation of track control and selected waypoint is too close for approach maneuver.	Check route.
TCS STOPPED TRACK TO FAR AWAY: CHECK ROUTE	Warning B	as Alarm to BN- WAS (30 s)*	Track control was not started. The track is more than 10 nautical miles away.	Track route.

Alert Title Alert Description	Category Priority	Escalation	Possible Cause	Remedy
TCS STOPPED CHECK ROUTE	Warning B	as Alarm to BN- WAS (30 s)*	Leg change maneuver was not initiated. Track control was interrupted.	Check connection and configuration of ECDIS, use heading control.
TCS STOPPED WAYPOINT NOT AHEAD: CHECK GOTO WAYPOINT	Warning B	as Alarm to BN- WAS (30 s)*		
TCS STOPPED TOO FAR AWAY FROM WAYPOINT	Warning B	as Alarm to BN- WAS (30 s)*		
TCS STOPPED NO SET COURSE: CHECK SET COURSE FROM ECDIS	Warning B	as Alarm to BN- WAS (30 s)*	Track control interrupted, no leg course received from ECDIS.	Check ECDIS
TCS STOPPED NO POSITION: CHECK POSITION SENSOR	Warning B	as Alarm to BN- WAS (30 s)*	Track control stopped, no position data available.	Check position sensors.
TCS STOPPED NO XTE: CHECK CROSS TRACK ERROR FROM ECDIS	Warning B	as Alarm to BN- WAS (30 s)*	Track control interrupted, no cross track error received from ECDIS.	Check ECDIS
TCS STOPPED POSITION JUMP: CHECK POSITION	Warning B	as Alarm to BN- WAS (30 s)*	Track control interrupted, position jump detected.	Check position sensors

Alert Title Alert Description	Category Priority	Escalation	Possible Cause	Remedy
TCS STOPPED MAG HDG SELECTED: SELECT GYRO HEADING	Warning B	as Alarm to BN-WAS (30 s)*	Track control interrupted, magnetic heading source selected.	Select gyro heading source.
TRCK-CRS-HDG.DIFF TAKE HELM TO KEEP COURSE STEADY	Warning A	as Warning	Difference between actual heading and leg course exceeds operator adjusted off course limit.	Check surroundings, high drift or other disturbances present.
WP APPROACH APPROACH NEXT WAYPOINT	Warning A	as Warning	Track control in accordance with IEC62065:2002 configured. Next way-point in 3 min.	
AP NOT ACTIVE AUTOPILOT NOT ACTIVE: ACTIVATE HDG CONTROL	Caution B		Heading control has to be active to activate Track control	Activate Heading control
APPROACH WP APPROACHING NEW WAYPOINT	Caution B	none		
CC UNAVAIL. NO POSITION: CHECK POS SENSORS	Caution B	none	No position information available so Course control is not usable.	Check position sensors.
GYRO NOT SEL NO TCS OR CC WITH MAG: SELECT GYRO HEADING	Caution B	none	TCS may not be used in when a magnetic heading source is selected	Select Gyro compass as heading source
HCS UNAVAIL. NO HEADING: CHECK HDG SENSORS	Caution B	none	Activation of Track or Course control while no speed is available - activation not possible.	
MISSING WP MISSING WAYPOINTS	Caution B	none		

Alert Title Alert Description	Category Priority	Escalation	Possible Cause	Remedy
NEW TRACK NEW TRACK 000°	Caution B	none	Track change maneuver is complete.	none necessary.
NO RADIUS NO APPROACH RAD. DEFINED	Caution B	none		
NO TRACK CRS CHECK CONNECTION TO ECDIS	Caution B	none		
NO TRC DATA CHECK CONNECTION TO ECDIS	Caution B	none		
NOT SPD ADAPTIVE NO SPEED: CHECK SPEED SENSOR	Caution B	none	Activation of Track or Course control while no speed is available - activation not possible.	
POWER FAIL. CHECK POWER SUPPLY	Caution B	none		
TCS NOT ACTIVAT. APPROACH ANGLE GREATER THAN 60°	Caution B	none	Track control can only be activated if actual heading is within a cone of +/- 60° from the leg course.	Steer the ship, so it is within the cone, adjust track
TCS NOT ACTIVAT. ACTIVATE TRACK CONTROL ON ECDIS	Caution B	none	Attempted to activate Track at the Operator unit.	Track control mode can only be activated at ECDIS
TCS UNAVAIL. NO POSITION: CHECK POS SENSORS	Caution B	none	No position information available so Track control is not usable.	Check position sensors.
TCS UNAVAIL. NO POSITION: CHECK POSITION	Caution B	none	No position data available, AP is not in track control. Track control cannot be activated.	Check position sensors.

Alert Title Alert Description	Category Priority	Escalation	Possible Cause	Remedy
WP CHANGED WAYPOINTS HAVE CHANGED	Caution A	none	The current TO-Waypoint was changed while in track control	
XTE EXCEEDED OFF TRACK CROSS TRACK LIMIT EX- CEEDED	Alarm A		Ship is outside of adjusted limits around the current leg.	Check surroundings, use manual steering
XTE MISSING CHECK CONNEC- TION TO ECDIS	Caution B	none		
XTE TO LARGE XTE GREATER THAN 000NM	Caution B	none	Activation of track control from ECDIS, XTE is greater than 1 nautical mile	

Tab. 14: Alerts Course Control

Alert Title Alert Description	Category Priority	Escalation	Possible Cause	Remedy
CC STOPPED NO HEADING: USE MANUAL STEERING	Alarm B	to BN- WAS	Course control stopped, Heading information missing	Check heading information, use manual steering
CC STOPPED NO SPEED: CHECK SPEED SENSOR	Alarm B	to BN- WAS	Course control stopped, Speed information missing	Use manual steering or HDG control
CC STOPPED NO POSITION: CHECK POSITION SENSORS	Warning B	as Alarm to BN- WAS	Course control was stopped since no position data is available. Heading control is active, actual heading is used as set heading.	Check position sensors. Use Heading control or manual steering.
CC STOPPED MAG HEAD- ING SELECTED: SELECT GYRO HEADING	Warning B	as Alarm to BN- WAS	Course control was stopped since a magnetic heading sensor was selected.	Select a Gyro heading sensor.

Alert Title Alert Description	Category Priority	Escalation	Possible Cause	Remedy
CC STOPPED POSITION JUMP: CHECK POSITION	Warning B	as Alarm to BN- WAS	Position jump detected, Course control is interrupted. Fallback is Heading control.	
HDG MONITOR HEADING INTEGRITY LOW: CHECK HEADING SENSORS	Warning B		Doubtful heading information or heading monitor not available	Check heading information, use manual steering
NO POS MON DEAD RECKONING NOT AVAILABLE	Warning A	as Alarm	Position monitoring not possible, lack of data	Check connected sensors
OFF COURSE DISTANCE TO COURSE LINE EXCEEDS LIMIT	Warning A		Distance to course line exceeds operator adjusted limit.	Check surroundings, use manual steering
POS DOUBTFUL POSITION DIFFERENCE: CHECK POSITION SENSORS	Warning A	as Warning	Position monitor detected a difference between position information.	Check position sensors, use heading control.
BACK. POS CHNG BACKUP POSITION SENSOR CHANGED	Caution B	none	Backup Position sensor for position monitoring changed.	None necessary.
CC NOT ACT. ACTIVATE HDG CONTROL	Caution B	none	Heading control has to be active to activate Course control	Activate Heading control
CC NOT AVAIL. TURN RATE TOO FAST (LIMIT:30°/MIN)	Caution B	none	Ship is turning to fast - Course control can not be activated	Wait until the turn is completed.
CC UNAVAIL. CC NOT INCLUDED, USE HDG CTRL	Caution B	none	Course control is not available for this device	Upgrade License
CC UNAVAIL. MAG HEADING SELECTED	Caution B	none		

Alert Title Alert Description	Category Priority	Escalation	Possible Cause	Remedy
CHECK DR CHECK DEAD RECKONING DRIFT SETTINGS	Caution B	none	Position monitor for Course control uses DR. Default settings used for drift and set.	Check settings for position monitor
CRS APPROACH COURSE AP- PROACHING	Caution B	none	Activation of Course control or Set course change in course control.	
NO BACKUP POS NO BACKUP POSITION USING DEAD RECKONING	Caution B	none	Dead reckoning is used for position monitoring.	None necessary.
POS MON SOG DEAD RECKONING WITH SOG: CHECK SPEED SENSOR	Caution B		Position monitor uses a dead reckoning position for comparison.	

Tab. 15: Alerts Track Control Old

Alert Title Alert Description	Category Priority	Escalation	Possible Cause	Remedy
CHANGE TRACK CHANGING TRACK TO 000°	Alarm A	to BN- WAS	Only active if AP is configured for IEC62065:2002. Actual Course change warning (30 s prior to WOL)	
CHANGE TRACK CHANGING TRACK TO 000°	Alarm A	as Alarm to BN- WAS	Only active if AP is configured for IEC62065:2002. Actual Course change warning (WOL already passed)	
NEW CRS 30S COURSE CHANGE IN 30 SECONDS	Warning A (30 s)*		Track 62065:2002, actual track change warning.	

Alert Title Alert Description	Category Priority	Escalation	Possible Cause	Remedy
NEW CRS 3MIN COURSE CHANGE IN 3 MIN	Warning A (30 s)*		Track 62065:2002, early track change warning.	
TCS UNAVAIL. TRACK CONTROL NOT AVAILABLE	Warning B	as Alarm to BN- WAS	Track 62065:2002, impossible track warning.	Track route.

* The escalation time of this alert varies from the regular escalation time of 1 minute.